



BMW Lifestyle

2010/2011



Sheer
Driving Pleasure

BMW LIFESTYLE ^{10/11}

DISCOVERING JOY.

THE FASHION DESIGNERS: JOY BECOMES STYLISH.

A BIKE IS BORN: FROM DRAWING BOARD TO RIVERBED.

BMW ORACLE RACING: THE BATTLE OF VALENCIA.

BMW AT THE NÜRBURGRING: FULL THROTTLE, 24 HOURS.

JOY

is interested. Interested in life. And in all the things that can be discovered every day. Welcome to BMW Lifestyle. Discover how Andy Priaux feels during a 24-hour race, immerse yourself in the fascinating world of BMW Miniatures and find out why every BMW Bike has some automotive DNA. You can find an overview of all products from page 28 onward. This is where the entire BMW Lifestyle Collection awaits you: from the new BMW M Leather Jacket to the BMW Mountain Bike Cross Country. Made for a life in motion. And for every day. We hope you'll enjoy the following pages.

BMW COLLECTION. Joy makes you look good.	04 09
BMW M COLLECTION. M: the most powerful letter in the world.	10 11
BMW BIKES & EQUIPMENT. Be the engine.	12 15
BMW KIDS' COLLECTION. The joy has just begun.	16 17
BMW MINIATURES. Discover the details.	18 19
BMW YACHTSPORT COLLECTION. The battle of Valencia.	20 21
BMW MOTORSPORT COLLECTION. The story of the beast.	22 25
BMW GOLFSPORT COLLECTION. Driven by passion.	26 27
BMW LIFESTYLE COLLECTIONS.	28 105

 **QUICK LINK**
The quickest way to BMW Lifestyle. The links provided will get you straight to the web pages for each collection.

 **THE CATALOGUE**
Experience the entire range: the page numbers listed here will get you to the other products from each collection.



04

BMW COLLECTION.
Modern designs and top-quality materials – the BMW Collection 2010/2011.



18

BMW MINIATURES.
Economies of scale: a look at how BMW Miniatures are made.

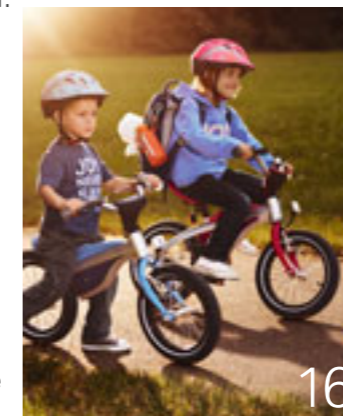

16

BMW KIDS' COLLECTION.
You can never start too early. Find out why the BMW Kidsbike also brings plenty of joy.



12

BMW BIKES & EQUIPMENT. Italian for advanced learners. The big BMW Bike test at Lake Garda.



20

BMW YACHTSPORT COLLECTION.
The chronicle of a triumph: BMW ORACLE Racing at the 33rd America's Cup.



10

BMW MOTORSPORT COLLECTION.
Of beasts and sleepless nights. The big fan feature from the Nürburgring 24-hour race.

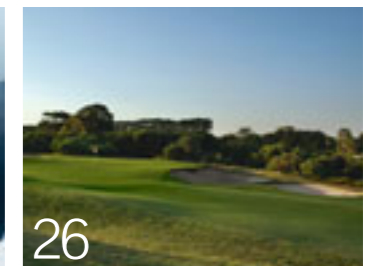

26

BMW GOLFSPORT COLLECTION.
Green is for go: the most beautiful golf courses in the world, from Scotland to Australia.



22

BMW M COLLECTION.
Generation M: a brand and its philosophy.



JOY MAKES YOU LOOK GOOD.

Can fashion bring you joy? We think so. To prove our point, we developed the current BMW Collection. With a fascinating range of colours, materials and combination options, it goes well with every style and offers you plenty of scope for redefining your look every day – while staying true to yourself. With contemporary designs, top-class materials and select accessories.

Our JOY Collection is really rather self-explanatory. On some of the items, its motto is perfectly obvious, for example when spelled out in large letters on the T-shirts; on others, it's all about the details. Whichever you choose: joy makes you look good – the new BMW Collection 2010/2011.



Right: BMW Titanium Sports Style Sunglasses (p. 49)

He: Men's Knitted JOY Sweater (p. 37), BMW Quartz Chrono Men's Watch (p. 48). She: Ladies' JOY Polo Shirt (p. 39).



BMW Cap, White (p. 33), Men's JOY Polo Shirt (p. 39) and BMW Quartz Chrono Men's Watch (p. 48).



Ladies' T-Shirt (p. 35) and Ladies' Hooded JOY Jacket (p. 38).



Men's Polo Shirt (p. 33) and BMW Titanium Sports Style Sunglasses (p. 49).



He: Men's Polo Shirt (p. 33) and BMW Quartz Chrono Men's Watch (p. 48). She: Ladies' Fleece Jacket (p. 34) and Ladies' T-Shirt (p. 35).

The fleece jacket from the BMW Collection combines good looks with environmental awareness. You wouldn't be able to tell that it's made from what used to be 16 PET bottles. The recycled fabric gives no clue to its provenance, and the jacket is not only breathable but also exceedingly soft and cosy. This transformation is made possible by an innovative process during which shredded PET bottles are spun into thin fibres. The result: environmentally sound fashion that looks great and feels right.



He: Men's Polo Shirt (p. 33). She: Ladies' T-Shirt (p. 35).

Our T-shirts and polo shirts prove that comfort and contemporary design go exceedingly well with environmental responsibility. They are made from 100% organic cotton. This means that chemical fertilisers and pesticides are as taboo as harmful substances, practices, and processes during production. As a result, these shirts are a joy not just to their wearers.



QUICK LINK
www.bmw-shop.com/collection



All products on catalogue
 pages 30–55.

M: THE MOST POWERFUL LETTER IN THE WORLD.



THE JOY OF THE UNUSUAL IS WHAT DEFINES BMW M AUTOMOBILES AS WELL AS THE ENTIRE BMW M COLLECTION. DISCOVER THE ALLURE OF THE MOST POWERFUL LETTER IN THE WORLD.

There is a letter that expresses a whole mindset: M. Like no other, it represents extraordinary dynamism, innovative technologies, and true motorsport excitement. With the BMW M Collection, you can enjoy this feeling even away from the road.

Even the materials blur the lines between fashion and automotive engineering. The sporty carbon-style details from the current BMW M Collection pay homage to the carbon roof of the BMW M3.

And the double-spoke design of the light-alloy M rims is reflected, among others, in the zip pulls of the M Collection. It goes

without saying that each product of the new collection is made for a show-stopping entry, hallmark BMW M style.



QUICK LINK
www.bmw-shop.com/mcollection



All products on catalogue
pages 56–65.

He: M Men's Leather Jacket (p. 58), M Men's T-Shirt Red (p. 61). She: M Ladies' Studed T-Shirt (p. 60).



ALWAYS A WHEEL'S LENGTH AHEAD.

The history of BMW Bikes is also a history of innovations. Take the aluminium frame and the suspension fork: BMW Bikes pioneered both of them. Something they have been doing for more than 60 years.

Success stories sometimes start with a talent for improvisation. In the post-war Germany of the early 1950's, raw materials were hard to come by. Their lack was met with ideas: steel helmets became pots; uniforms were transformed into coats with the help of fabric dyes. The BMW engineers were just as inventive when they created our first

This is how BMW contributed to the use of suspension forks in mountain bikes.

Over the following years, BMW not only perfected the suspension fork, but also the folding principle – after all, the bikes were supposed to fit into the luggage compartment of a BMW. All this, of course, without cutting down on comfort: BMW was an early adopter of the "Speedtronic" automatic transmission which shifts gears electronically.

The year 2000 marked the birth of the BMW Q Bikes, which once again underlined BMW's pioneering position. This started

design is coupled with the knowledge of what makes a bicycle a BMW Bike. The standards applied are the same as for automobiles, which are marked by their dynamic lines and accelerating radii.

But it is a long way from the design stage to production. After the prototype build, a new BMW Bike first goes into the lab, where it is made to cover thousands of miles on a roller-type test stand, with various sand bags taking the place of the rider. The tests are based on the DIN Plus standard, considered the most stringent test standard in the world.

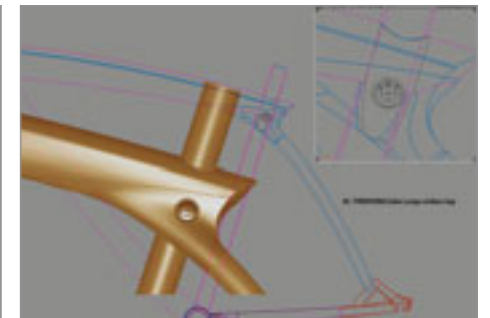

Top: One of the first BMW light-metal bicycles, 1950. Bottom: BMW Mountain Bike Enduro, 2011 (p. 69)

bicycle: instead of resorting to rare steel, they used aluminium.

The result was years ahead of its time: aluminium only became a staple for bicycle frames in the 1980s – while BMW had patented its aluminium frame some 30 years earlier. The use of light metals was not the only innovation in early BMW bicycles. A hub brake cable running through the head tube and a hand grip with integrated bell added further touches of originality. The fact that some of the early BMW bikes are still in use at the BMW works in Munich to this day pays tribute to their quality.

In the mid-1990s, bicycles made by BMW were once again at the leading edge of bicycle development. A pioneering group of engineers came up with the idea of adapting the suspension fork of a BMW motorbike for the BMW mountain bike. The fork, reproduced from a more lightweight material, was used for BMW folding bikes.

with the design – the Q Bikes were among the first bicycles with hydroformed aluminium frames. Thanks to advances in telelever suspension design, these bikes also set new standards in terms of suspension technology.

Two years later, BMW also conquered the market for racing bikes. The use of carbon – then a relatively new material – for the forks further reduced weight. The result was impressive: at a weight of just 7.8 kilos, these bikes could still hold their own today.

The introduction of the fourth-generation BMW 7 Series also changed the focus for BMW bikes. With the departure of the folding bike, the focus has since been on design – just like you'd expect it from BMW.

No surprise then that new BMW Bikes now start their development on a product designer's monitor at BMW Designworks, the place where expertise in industrial

After component and stress testing, the bikes leave the lab, only to be subjected to another gruelling test environment: the heat of Death Valley or the icy cold of the polar region. The reason for this is the BMW test riders' desire to subject two-wheeled prototypes to the same kind of torture as the four-wheeled variety. Because a BMW Bike has to be just as tough as a regular BMW.



QUICK LINK
www.bmw-shop.com/bikes



All products on catalogue
pages 66–73.





Left: Refuelling at Lago di Ledro. If you prefer espresso to water, we recommend the "Bike Point" café near the lake. Top centre: Hairpin bend on the Ponale road. Bottom centre: Gravel path en route to Lake Ledro.



THE TREK TO PASSO ROCCHETTA NEAR LAKE GARDA IS ONE OF THE PRETTIEST IN EUROPE. MOUNTAIN BIKE WORLD RECORD HOLDER IGOR OBU TOOK THE BMW MOUNTAIN BIKE CROSS COUNTRY FOR A TEST RIDE.

TREK OF DREAMS.

The lake. There's always the lake. As Igor and I take off from Riva, Lake Garda is a shimmering expanse of dark blue in the light of the morning sun. This blue will be our companion for most of the day; sometimes framed by rocks,

sometimes glimpsed through trees. "Stop dreaming," Igor says. He is eager to get to the first trail. For now, he has to be patient, for the dream trek to Passo Rocchetta starts on the partly paved Ponale road. From the

lakeside, it snakes through tunnels, climbing 400 metres. Igor's BMW Cross Country is flying up the road. The bike weighs a mere 13 kg. He is climbing like a mountain goat, somewhere between third and fifth gear.

Time and again, he disappears into the darkness of a tunnel. Given Igor's speed, my guess is I won't be seeing much of the scenery. The boats on the lake below have become white dots, sailing along like shreds of clouds across the azure sky.

Rocchetta Tour Special
 Length: approx. 30 kilometres
 Profile: around 1,200 metres height difference
 Duration: 5 hours
 From Riva along the old Ponale road to Biacesa (closed to automobiles). Continue along the cycle path through the Ledro valley along the Ponale river. From Lago di Ledro towards Bocca dei Fortini. From there via Passo Guil and Passo Rocchetta towards Pregasina and back to Riva.
 Tip: Bar Panorama in Pregasina – cappuccino with a fantastic view.

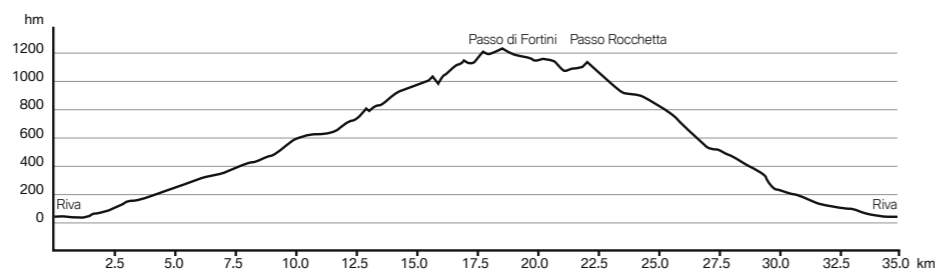

Top: Sharp incline, low gears: on the way to Passo Guil. Centre: It's all downhill from now – signpost at Passo Rocchetta. Bottom: A ride with a view. Leaving for Riva.



Centre: The difference between rock hard and buttery soft: the lockout lever. Bottom: Too much even for a pro – Igor capitulates in the face of large rocks on the trail.



Main picture: Though the tour had its torturous moments, the views of the lake are spectacular. Bottom: Not for beginners – the route to Pregasina will tempt you with single trails.

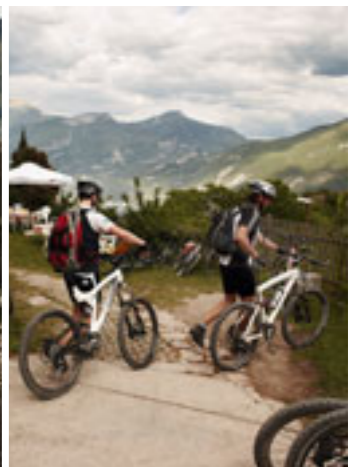

Arrival at Pregasina. On offer at the Bar Panorama biker hangout: pasta, ice cream and cappuccino. Out here, nobody bothers to lock their bikes – after all, you're among fellow bikers.

At Biacesa we exchange our lake vista for a river view. The route follows the Ponale river. Surfaces include gravel, tarmac and cobblestones. The route is challenging, and we are steadily climbing higher. Igor is riding as if it were a Sunday outing. I'm wondering what the other 29 gears on my bike are for. I only need the first one. We take a first break at the ice blue Lago di Ledro. From now on, we'll hit the hinterland. Time to fill up the drinks bottle. The next leg will see us climb another 650 metres to Bocca dei Fortini. "Just five kilometres

of trail," says Igor dismissively. First gear, anyone? Through the forest, on we climb, first on tarmac, then on gravelly paths. The trees are thinning quickly, and the air is getting cooler. Igor's BMW Cross Country whirrs across the gravel. "This is a racing bike for mountains," he says. Then he accelerates to leave me behind in a cloud of dust. We stop at the top at Bocca dei Fortini. Instead of continuing towards the grey Monte Tremalzo, we are now heading towards the blue Lago. The trail is turning narrower, more

gravelly and steeper. To the left, there are towering rock walls, to the right, a sheer drop – two hundred metres down and no railing. Rocks obstruct the path; roots are grappling with the wheels, trying to throw us off our bikes. After the Passo Rocchetta, we can once again see Lake Garda through the trees. Green, blue, green, blue. Middle cog, no lockout. The Cross Country's suspension eats up every bump. Stones? Roots? I see them, but I can hardly feel them. Suddenly there is smoke emanating from Igor's front

wheel. A dry leaf on the disc brake. We're pushing the limits. He and his BMW Bike are fine. I however, feel as if I've played 13 rounds of chess against Deep Blue – towards the end, I'm so unfocussed that my bike stumbles more across rocks than it rides. Once back on the Ponale road, the Lago lures us with its best cerulean blue. After five hours, we are back. Our heads full of picture-postcard views. Of the lake, of course.

THE JOY HAS JUST BEGUN.

Every day, children discover the world anew – and joy is always a part of it. Things getting a bit rough at times is just par for the course. Thankfully, the developers of the BMW Kidsbike factored in the way children move when designing this bike for our younger customers.

Even as a pushbike, the BMW Kidsbike promotes the joy of movement. It supports the development of children's motor skills more effectively than a tricycle or a bicycle with stabiliser wheels, because it teaches

children a sense of balance. Children learn early on how to keep the bike straight – which at first requires a lot of concentration. But after a few weeks' practice, this turns into pure fun, because they can build up more speed.

Of course, safety still comes first in all of this. This is ensured by removable handlebar padding, reflectors on the tyres, and solid plastic pedals. In addition, every BMW Kidsbike is supplied with a TÜV-approved safety helmet – so safety comes as part of the standard equipment.

Given this wealth of practical ideas it is hardly surprising that the BMW Kidsbike has won several design awards.



QUICK LINK
www.bmw-shop.com/kids



All products on catalogue
pages 74–83.

Functionality.

When a child is ready to move on to proper cycling, the chain and pedal unit supplied can be installed in no time to turn the pushbike into a real bicycle. And when the little ones grow, the Kidsbike simply grows along with them – the saddle can easily be raised to a higher position.





BMW Isetta 250, 1:12



BMW 550i Saloon (F10), 1:18 and 1:43



BMW 5 Series Gran Turismo (F07), 1:43



BMW X3 (F25), 1:18, 1:43 and 1:87



Concept Vision Efficient Dynamics, 1:43



DISCOVER THE DETAILS

It doesn't matter whether you see it on a twisting country road or on a polished mahogany desk: a BMW is always a fascinating sight. To ensure that BMW Miniatures look just as attractive as the originals, they are manufactured in close cooperation with BMW designers. This applies to BMW Art Cars as much as it does to the new BMW 5 Series. Every BMW Miniature delights with numerous details and precise workmanship.

At the start of production, the design department uses computers to process

the specifications laid down by the BMW engineers. To make sure that important details like the logo or windscreen wipers are both recognisable and robust enough to survive handling, simply miniaturising the original parts will not do. Instead, individual parts have to be redesigned almost from scratch.

Afterwards, a die-cast mould is fashioned for every component. This is so time-consuming that it can take up to ten weeks. But it is also well worth the effort: the die-cast moulds provide the framework for the

miniature's body and are filled with either molten plastic or zinc, depending on the scale. After a first, stringent quality control process, the casts enter the paint shop, where they are painted in three steps, using the same paint that is used for the respective full-sized BMW model.

After hardening and cooling it's time to tackle the details: the so-called tampon printing process enables us to print on even the smallest components. With our smallest-scale models, the results of this advanced process – for example a detailed

replica of the BMW logo on the bonnet – can only be fully appreciated when viewed through a magnifying glass.

Tiny chrome surfaces provide further exquisite details to enjoy. They make the exterior mirrors sparkle, for example, and are also used to give the radiator grille its trademark shiny appearance. Real carpeting in original BMW colours for the footwells and luggage compartment and realistic reproduction of leather upholstery seams make the interior of the 1:18-scale models look incredibly authentic. Once all

the details have been taken care of, the individual components are assembled into a real BMW – by hand. And it is this precise workmanship that makes BMW Miniatures so unique, turning every miniature into a true original.



QUICK LINK
www.bmw-shop.com/miniatures



All products on catalogue
 pages 84–87.

THE BATTLE OF VALENCIA.

The men on the "USA", the trimaran sailed by the BMW ORACLE Racing Team at the 33rd America's Cup, were driven by more than just the wind, or their innovative wing sail. After all, this contest was about the oldest and most coveted trophy in international yachting. And that is something you only win with a combination of team spirit, technology and strategy.

The event, which was conceived as a "Best of Three" series, saw the BMW ORACLE Team's trimaran beat the defending champion, the Swiss Alinghi, two times in a row. Teamwork was a key element of this victory, but so was a special innovation: the largest wing sail ever built. At 68 metres, the sail is more than twice as long as the wing of a Boeing 747. The triple hull of the 30-metre boat, developed in collaboration with BMW, is equally innovative. It took 150,000 man-hours to build by hand, using carbon composite materials in order to save weight. This lightweight

design makes the boat not just extremely fast, capable of reaching speeds up to 40 knots, but also very sensitive: when handled incorrectly, the BMW ORACLE can capsize at speeds as low as 10 knots.

Unlike the victory itself, the rules for the 33rd America's Cup were simple: whoever wins two of the three races has won the America's Cup. The first race on 12 February 2010 was an up-and-down course: the yachts had to travel 20 nautical miles against the wind, and then return. The "USA" crossed the finish line 15:28 minutes ahead of the Alinghi catamaran. The second race on 14 February was a triangular course with a total length of 39 nautical miles. BMW ORACLE Racing won this race as well, this time with a lead of 5:26 minutes.

Overall, the 33rd America's Cup once again represented a fascinating combination of tradition, innovation,

dynamism and passion. A combination that can also be found in the current BMW Yachtsport Collection.



The BMW ORACLE Racing Team did not just have to contend with the forces of nature, but also had to overcome language barriers. The team, led by New Zealand skipper Russell Coutts, included members from many different countries: America, Italy, France, Australia, the Netherlands and even Antigua. As the boat sailed under an American flag, all commands on board were issued in English.



QUICK LINK
www.bmw-shop.com/yachtsport



All products on catalogue
pages 88-93.



THE STORY OF THE BEAST.

EVERY YEAR: THE 24-HOUR RACE AT THE NÜRBURGRING.

It's 3.04 pm, and the beast stirs for the first time. At the Brunnchen section of the Nordschleife track, a generator chugs away; glasses clink on the camping table. The people in the neighbouring tent are listening to AC/DC – "Highway to Hell". But now a gravelly note seems to enter the singer's voice. He sounds like he's in need of a throat lozenge. A few more

seconds pass. Then the beast arrives. A moment later, the AC/DC song is no longer to be heard. "Vrrrrroooooo-aaaaaarrrrrrmmmm." The sound is so powerful that you feel the vibration in your gut. The ladies among the spectators put their hands over their ears. One second later, the BMW M3 GT2 has passed the Brunnchen straight and

enters the next corner. Dean leans back in his camping chair, reaches for his coffee mug and says: "Now it'll be quiet again for a few minutes." At least as far as the BMW is concerned, which takes around eight minutes to complete one 25.378 km lap on the Nürburgring Nordschleife. Dean lovingly refers to it as "the beast".

Among motorsport fans, Brunnchen is considered the best place to experience the 24-hour race at the Nürburgring. There is a colourful assortment of tents, parasols and gazebos and, in the background, the track – visible through a tall wire mesh fence and the smoke of barbecue fires.

If it weren't for this, and the music, snack bars and drinks vendors, Brunnchen could be just another campsite. Over 220,000 fans visit the Nürburgring each year, turning the Brunnchen, Schwalbenschwanz and Karussell meadows into their home from home. The British contingent usually arrives with jeeps and army vehicles, and if you are not there five days before the race, you won't find a space.

It is 10.43 pm now. The BMW has passed Dean's lookout, surrounded by deckchairs, radios and cool boxes, 61 times. Dean is oblivious to the campfire at the neighbouring tent, or the fireworks painting red circles into the night sky. He's seen it all before. Another 16 hours of motorsport fun, the smell of oil and rubber, and, if all goes well for the BMW Motorsport team, regular visits by the beast. One of 217 race cars whose engine roar does a better job of keeping you awake than any energy drink.

In the morning, the sun breaks through the trees. Shafts of light illuminate the site, revealing smouldering campfires, dew-covered tents and enthusiasts who have been following the race all night.

A still life, were it not for the race cars still circling the track. It is their rhythm that has kept Dean awake. He is squinting at the sun. Another eight hours before the BMW M3 GT2 will complete the race. Another 64 laps. Then the beast will finally rest.



QUICK LINK
www.bmw-shop.com/motorsport



All products on catalogue
pages 94–99.



What role does traffic play in an endurance race?

Andy Priaulx: Rhythm is everything. If you let a faster car pass at the wrong place, you lose time. The same applies if you are trying to overtake a slower vehicle at the wrong time. With every lap you learn more about how to read the traffic on the track.

What do you personally associate with the BMW M3?

Andy Priaulx: The car is powerful, aggressive and sporty. The BMW M3 is the product of the combined knowledge and enthusiasm of the BMW engineers. That's something that you feel as a driver. And it doesn't surprise me that the BMW fans attending the race experience that in the same way.

How do you prepare for a 24-hour race?

Andy Priaulx: If you compete in the World Touring Car Championship, you have to be fit anyway. But before 24-hour races, I do extra work on my stamina, so I'm as fresh in the last lap as I am in the first.

Do you sense the special atmosphere of a 24-hour race as a driver during the race?

Andy Priaulx: When you see the sun rising above the track at dawn, it's a unique atmosphere. And when you and your team have completed the race, you're just incredibly proud afterwards. And in need of sleep.

INTERVIEW.

Driver extraordinaire, strategic thinker and nerves of steel – Andy Priaulx.

The race driver from Guernsey is the 2004 European Touring Car Champion and a three-time WTCC World Champion. But he has also had brilliant success in endurance races. His biggest triumph came in 2005 on the Nürburgring Nordschleife, when he won the 24-hour race, driving a BMW M3 GTR. "It was certainly one of the most important victories of my career", Priaulx says. In addition to his return to the "Green Hell" in 2010, Priaulx is also looking forward to his participation in the 24 Hours of Le Mans. "After Formula One, participating there is the ultimate dream of any driver."

What does a driver have to do to be successful in an endurance race?

Andy Priaulx: Consistency is immensely important. And you must be able to work in perfect harmony with the other team members. But sprint abilities play an increasing role as well.

Is team work even more important in endurance races than in sprint races?

Andy Priaulx: For drivers, certainly. But the same also applies to engineers and mechanics. Everyone has to deliver a top performance in a 24-hour race, both mentally and physically. And that is not just in the race itself, but also in the days preceding the race.

Is there a secret that enables a driver to drive fast in the dark?

Andy Priaulx: It's a very special challenge. You need intuition, and you need to be able to rely on your senses. A night in the cockpit can be a pretty lonely affair.



She: Ladies' Motorsport Polo Shirt (p. 97). He: Men's Motorsport Polo Shirt (p. 96), Motorsport Lanyard (p. 99).

“WHEN YOU SEE THE SUN RISING ABOVE THE TRACK AT DAWN, IT'S A UNIQUE ATMOSPHERE.”



The Royal and Ancient Clubhouse at the 18th hole of the Old Course in St. Andrews is only accessible to club members.



The course of the Royal Melbourne Golf Club, founded in 1891, ranks among the best in the Southern Hemisphere.

DRIVEN BY PASSION.

With the BMW Golfsport Collection, you will cut a fine figure on any golf course in the world. But which of the world's courses is the most beautiful is a harder matter to settle. The BMW Golfsport editorial team presents three candidates for the title of "the world's most beautiful golf course".



Royal Ancient Golf Club, Scotland.

The mother of all golf courses. The oldest and most famous golf course in the world. When conversation turns to the Old Course of the Royal and Ancient Golf Club in St. Andrews, golfers cannot help use superlatives. What is it that makes the course such a legend? The imposing club house, which dates back to the 19th century, overlooks the last tee, radiating the authority of a building whose golfing rules became a standard adopted across the world. The course itself holds many challenges: hidden pot bunkers, unpredictable winds, very hard fairways and tricky greens. But despite such difficulties and the Scottish weather – this course is a unique experience for any golfer.

Length: 6609 yards
Par: 72

Pebble Beach, California.

Ideal Californian weather and a superb panorama make it difficult to concentrate on the real reason for a visit to the Pebble Beach golf course: playing golf. But that is no doubt what Jack Neville and Douglas Grant had in mind when they designed the course in 1919, making sure that as much as possible of the course would run along the picturesque coastline. To be more precise, holes 4–10 and 17–18 are directly adjacent to the coastline. The 7th hole, which is only 90 metres long, lies at the very tip of a promontory and is the most photographed hole in the world. With a green fee of almost \$500, the course is superlative in other ways as well: it is one of the most expensive in the world. But that is probably the only thing that can dampen enthusiasm for this course.

Length: 6749 yards
Par: 72

Royal Melbourne Golf Course, Australia.

While not as well known as the other two, the Royal Melbourne Golf Club course is definitely worth a visit. Its biggest challenge are its greens, which demand the utmost skill from golfers. They are surrounded by distinctive sand bunkers, dug deep into the soil, which lend the Royal Melbourne course its unique character. There is none of the almost sterile precision here that has marked the recent trend in bunker design. In this way, the course retains its unpredictable nature and unique beauty – making it a perfect advertisement for Melbourne and all of Australia.

Length: 6589 yards
Par: 72



QUICK LINK
www.bmw-shop.com/golfsport



All products on catalogue
pages 100–105.

COLLECTIONS.

BMW COLLECTION. Basic. JOY. Organic Cotton. Business and Travel Luggage. Accessories.	30 55
BMW M COLLECTION. Fashion. Accessories. Travel Luggage.	56 65
BMW BIKES & EQUIPMENT. BMW Mountain Bike Cross Country & BMW Mountain Bike Enduro. BMW M Bike. BMW Cruise Bike. BMW Touring Bike. BMW Bikes & Equipment.	66 73
BMW KIDS' COLLECTION. Fashion. Accessories. BMW Kidsbike. BMW Baby Racer. BMW Pedal and Electric Cars.	74 83
BMW MINIATURES.	84 87
BMW YACHTSPORT COLLECTION. Fashion. Accessories.	88 93
BMW MOTORSPORT COLLECTION. Fashion. Accessories.	94 99
BMW GOLFSPORT COLLECTION. Fashion. Golf Bags. Accessories.	100 105
THE MOST CONVENIENT WAY TO BMW LIFESTYLE.	106 107



66

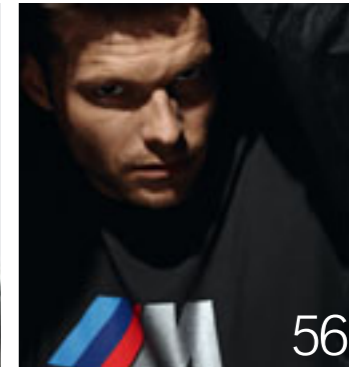

56

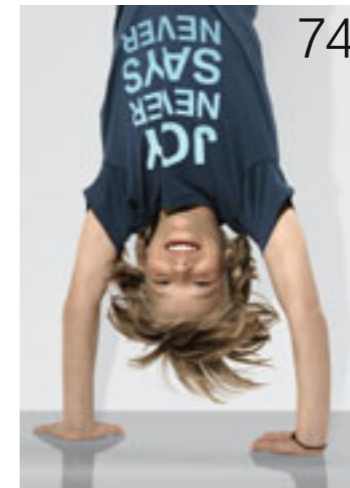

74



94

88

100



40

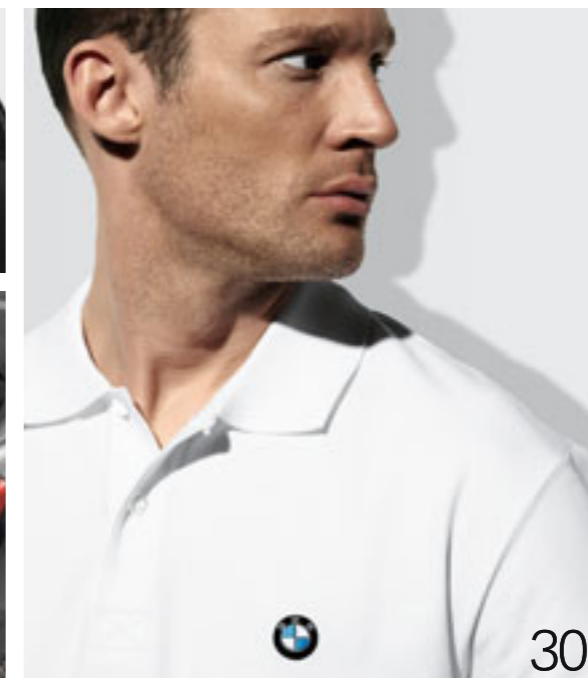

30



74



100

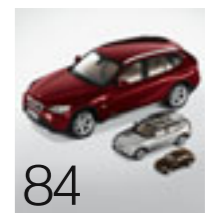

84

BMW COLLECTION.

Joy is attractive. And joy always looks good. The products from the BMW Collection offer you the right look for any occasion. Whether you prefer sporty or elegant, our contemporary designs, quality materials and love of detail ensure you will always look your best. For shopping, business meetings, or leisure trips.

JOY IN EVERY MOMENT.



Joy is BMW.

Joy is an integral part of everything we do at BMW, including the new products of our current JOY line. They all feature our credo as a fashionable detail on the inner neck area. So you can enjoy the new BMW Collection even more.



JOY NEVER SAYS NEVER.

Joy loves details. All JOY garments feature a specially developed woven tape with the JOY NEVER SAYS NEVER message. A message that is delivered twice: on the interior as a neck tape, and on the outside as an additional design element.



Organic Cotton.

Cotton fabrics for the BMW Collection are without exception sourced from certified organic producers. Environmentally harmful substances and practices are strictly taboo.



Men's Jacket. Sporty 2-in-1 jacket, wind and water-repellent. Removable quilted inner jacket in contrasting colour. Jacket and inner jacket with fashionable details. Embossed metal BMW logo on the pocket. Slim fit. Material outer jacket: 100% cotton with coating. Material inner jacket: 100% polyester.

Dark Blue
S-XXL 80 12 2 146 302-306



Men's Jacket. Fashionable men's jacket made from wind and water-repellent Soft Shell fabric – for any kind of weather and every occasion. Functional features: stand-up collar with foldaway hood, adjustable hem width, cuffs with adjustable hook-and-loop strips and side zip pockets. The coloured, rubberised BMW logo, the BMW-specific zip pull, the superior comfort of the breathable fabric and the additional inner pocket provide further highlights. Material: 100% polyester. Soft Shell.

Black
S-XXL 80 12 2 166 767-771



Men's Fleece Jacket. The feel-good factor: sporty leisure jacket made of soft fleece in stylish dark blue with stand-up collar. The hem with windstopper function and the recycled, breathable fabric ensure a pleasant level of comfort in any kind of weather. Other highlights include the coloured embroidered logo at chest level, the side zip pockets and the collar with white edging. Material: 100% recycled polyester micro fleece.

Dark Blue
S-XXL 80 14 2 166 762-766



Dark Blue
S-XXL 80 14 2 166 737-741
XXXL 80 14 2 180 633

Black
S-XXL 80 14 2 166 742-746
XXXL 80 14 2 180 634



White
S-XXL 80 14 2 166 732-736
XXXL 80 14 2 180 632

Men's T-Shirt. Goes with everything: the classic men's T-shirt with round neckline and embroidered BMW logo at the top left is the perfect basic piece for almost every look. The certified organic fabric and environmentally-friendly production ensure that it feels as good as it looks. Material: 100% organic cotton.

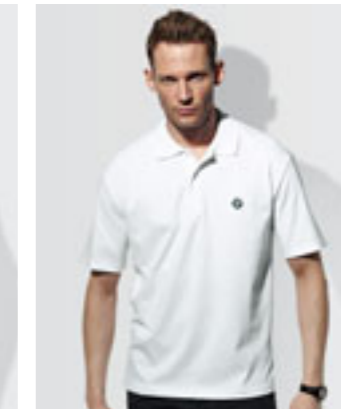
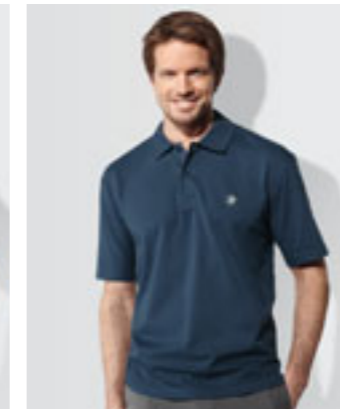

Men's Polo Shirt. Dress for success: the classic men's polo shirt with stylish collar and two-button placket has a coloured BMW logo embroidered at chest level. But there's more than meets the eye, such as the certified organic cotton fabric that has been manufactured in an environmentally friendly process. Material: 100% organic cotton.

Black
S-XXL 80 14 2 166 757-761
XXXL 80 14 2 180 637

Dark Blue
S-XXL 80 14 2 166 752-756
XXXL 80 14 2 180 636

White
S-XXL 80 14 2 166 747-751
XXXL 80 14 2 180 635

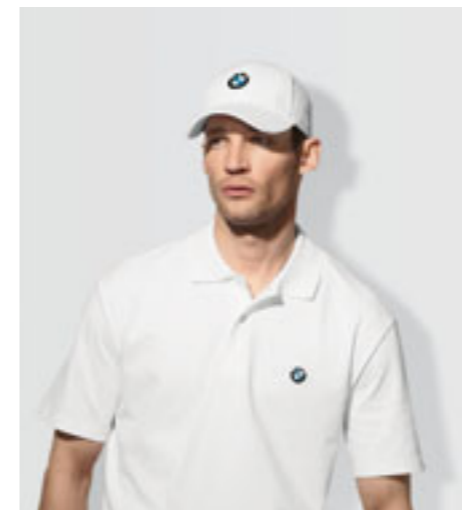

BMW Cap. Classic baseball cap with coloured embroidered BMW logo at the front.



White
80 16 2 166 852

Black
80 16 2 166 854

Dark Blue
80 16 2 166 853

BMW COLLECTION
BMW M COLLECTION
BMW BIKES & EQUIPMENT
BMW KIDS' COLLECTION
BMW MINIATURES
BMW YACHTSPORT COLLECTION
BMW MOTORSPORT COLLECTION
BMW GOLFSPORT COLLECTION



Ladies' Jacket. Contemporary ladies' jacket made from breathable, wind and water-resistant Soft Shell fabric. Numerous functional features such as the stand-up collar with foldaway hood, adjustable hem, cuffs with adjustable hook-and-loop strips and side zip pockets make this jacket the ideal year-round companion for every weather. With coloured, rubberised BMW logo at the top left and special BMW zip pull.
Material: 100% polyester Soft Shell.

Black
XS-XL 80 12 2 166 837-841



Ladies' Fleece Jacket. Looks good and feels good: super soft, dark blue fleece jacket with coloured embroidered BMW logo on the left sleeve, two side slit pockets and special BMW zip pull. The tall stand-up collar can be folded down and has the same white edging as the zip. The breathable recycled material provides an exceptional level of comfort.
Material: 100% polyester micro fleece.

Dark Blue
XS-XL 80 14 2 166 832-836



Ladies' JOY Down Jacket. With its large hood and contemporary tailored cut, this thick down-filled jacket makes even grey winter days look instantly more agreeable – not least thanks to the JOY promise printed on the back. The jacket is wind and water-repellent and breathable, making it an all-weather favourite. Two zip pockets at the front and white piping along the hood and zip add the finishing touches to this perfect winter jacket.
Material: 100% polyester.
Filling: 80% duck down, 20% duck feathers.
Insulation: 600 fill power.

Black
XS-XL 80 12 0 494 941-945



Ladies' T-Shirt. You can never have enough of these: the classic, high-quality ladies' T-shirt with its feminine round neckline and coloured embroidered BMW logo on the sleeve is the perfect basic piece for all occasions. Made from certified organic cotton fabric that has been manufactured in an environmentally friendly process and feels as good as it looks. Material: 100% organic cotton.

Black
XS-XL 80 14 2 166 812-816
XXL 80 14 2 180 640



Light Blue
XS-XL 80 14 2 166 807-811
XXL 80 14 2 180 639

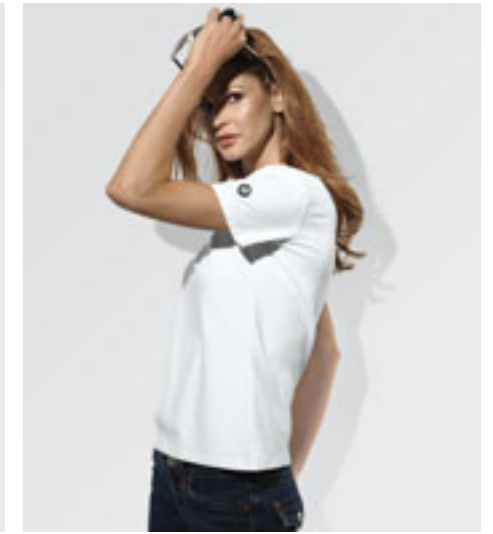

White
XS-XL 80 14 2 166 802-806
XXL 80 14 2 180 638

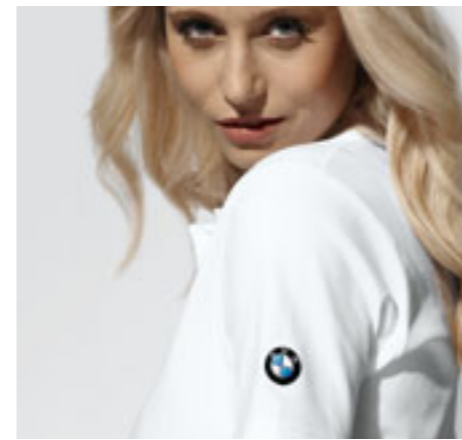

Ladies' Polo Shirt. Sporty and kind to the planet: this polo shirt with a covered two-button placket and classic collar is made from 100% certified organic cotton fabric that has been manufactured in an environmentally friendly process. It is ideal for events – and everything else that brings you joy. Material: 100% organic cotton.

White
XS-XL 80 14 2 166 817-821
XXL 80 14 2 180 641



Dark Blue
XS-XL 80 14 2 166 822-826
XXL 80 14 2 180 642



BMW Beanie. Goes with the BMW knitted sweaters and fits both ladies and men: the black beanie hat with coloured embroidered logo at the front. The innovative wool mix keeps your ears warm and ensures superior comfort.

Black
80 16 2 166 856

BMW Scarf. A must-have for male and female BMW fans, this elegant knitted scarf is made from an especially comfortable wool mix with a coloured embroidered logo.
Material: 10% Angora, 25% nylon, 25% viscose, 40% wool.

Black
80 16 2 166 857





JOY IS OUR PROMISE.

Everything we do day by day we do in the spirit of keeping driving pleasure alive. In the name of joy we use innovative lightweight materials to overcome gravity. We are constantly improving our engines to get the maximum out of every drop of fuel. We develop cars with ever lower drag coefficients. Far from content with just using less energy, we simply generate it ourselves. Each of our models benefits from the innovative power of BMW EfficientDynamics: technologies which preserve the joy of driving. And because joy is our aim, you can enjoy every drive in your BMW with a clear conscience. This is our promise.

BMW EFFICIENT DYNAMICS.



Men's JOY T-Shirt. Joy is conspicuous: with its fashionably graduated "JOY NEVER SAYS NEVER" motto and embroidered BMW wordmark on the sleeve, this roundneck shirt is bound to stand out. Material: 100% cotton.

Dark Blue
S-XXL 80 14 2 166 702-706

Ladies' JOY T-Shirt. Joy through fashion: this unusual ladies' T-shirt with its large, fashionably graduated "JOY NEVER SAYS NEVER" print shows immediately how joy makes everything look better. Other JOY details complete the look. Material: 95% cotton, 5% elastane.

Cream White
XS-XL 80 14 2 166 772-776

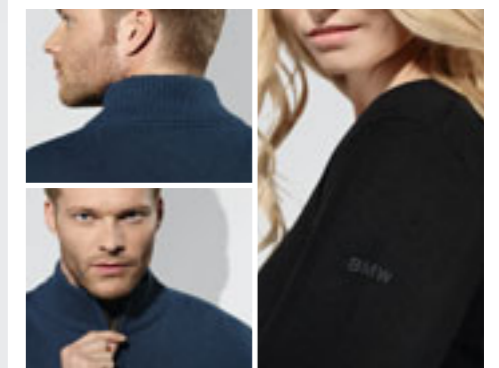
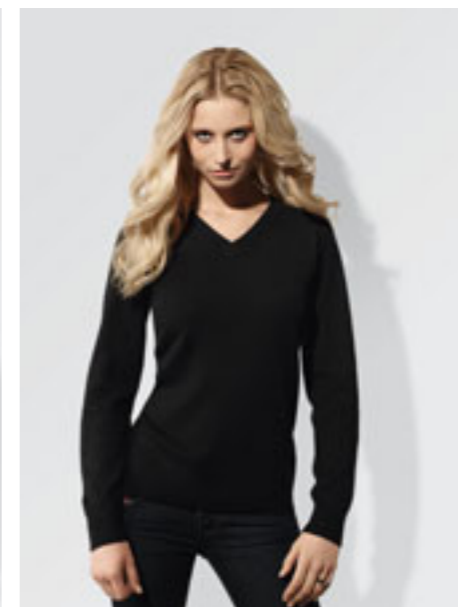

Men's Knitted JOY Sweater. Joy doesn't just warm you from the inside. This knitted men's sweater with its special materials mix provides a pleasant level of comfort. It is also quite handsome – thanks to details like the special BMW zip pull, the embroidered BMW wordmark on the sleeve and the light blue stripe design on the inside of the collar. The trademark JOY details ensure you will be looking forward to this winter. Material: 10% Angora, 25% nylon, 25% viscose, 40% wool.

Dark Blue
S-XXL 80 14 2 166 717-721

Ladies' Knitted JOY Sweater. This is how joy feels: with its innovative wool mix, this classic, feminine knitted V-neck sweater provides superior comfort. Cuffs and neckline are stylishly ribbed and the left sleeve features a discreetly embroidered BMW wordmark, making this piece equally suited for business and leisure. Material: 10% Angora, 25% nylon, 25% viscose, 40% wool.

Black
XS-XL 80 14 2 166 787-791



Ladies' Hooded JOY Jacket. Best worn with a smile: after all, this contemporary hooded jacket will give you plenty to be happy about. Including a special fabric finish for exceptional comfort and a tonal embroidered wordmark on the sleeve. The hood with its blue lining, the side slit pockets and the ribbed cuffs and hem make this jacket an ideal leisure companion.
Material: 90% cotton, 10% elastane.

Cream White
XS–XL 80 14 2 166 792–796

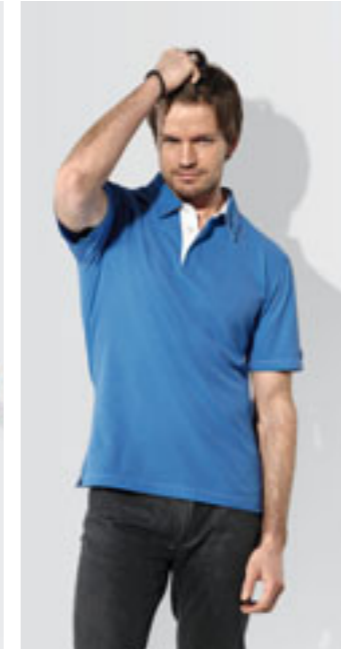

Men's JOY Polo Shirt. Joy looks good: this fashionable polo shirt with a covered two-button placket in a contrasting colour and matching collar lining and seams will help you look great wherever you are. After all, you can never have enough joy in your life.
Material: 100% cotton.

Brown Black
S–XXL 80 14 2 166 707–711

Blue
S–XXL 80 14 2 166 712–716

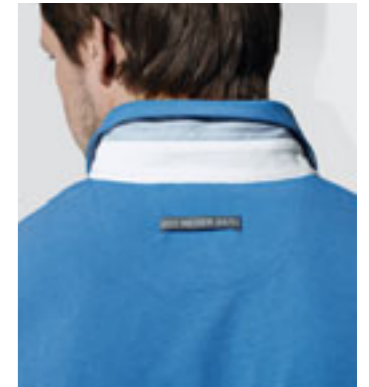
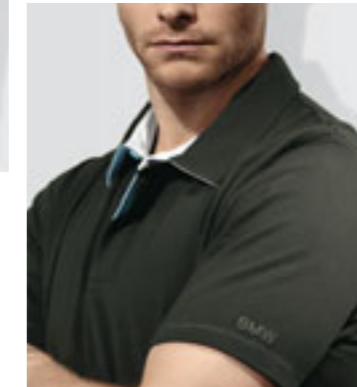

Men's Hooded JOY Jacket. Here are a few things to look forward to: a hood with cream white lining, two side slit pockets, a covered zip with BMW zip pull, tonal BMW wordmark on the sleeve and ribbed cuffs and hem. And a super soft hooded jacket that combines style and sportiness in a laidback fashion. The new JOY details as well as an extraordinary level of comfort are all part of the standard equipment for this jacket.
Material: 90% cotton, 10% elastane.

Brown Black
S–XXL 80 14 2 166 722–726

Ladies' JOY Polo Shirt. Joy has a sporty side: fashionable, pleasantly soft ladies' polo shirt with covered two-button placket in a contrasting colour and tonal embroidered BMW wordmark on the sleeve. The contrasting seams along the sleeves and hem, the matching collar lining and the light blue piping along the side slits provide additional accents – while perfecting your look.
Material: 100% cotton.

Blue
XS–XL 80 14 2 166 782–786

Cream White
XS–XL 80 14 2 166 777–781

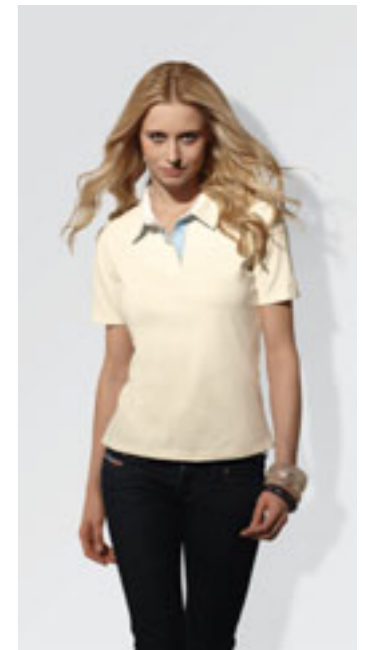
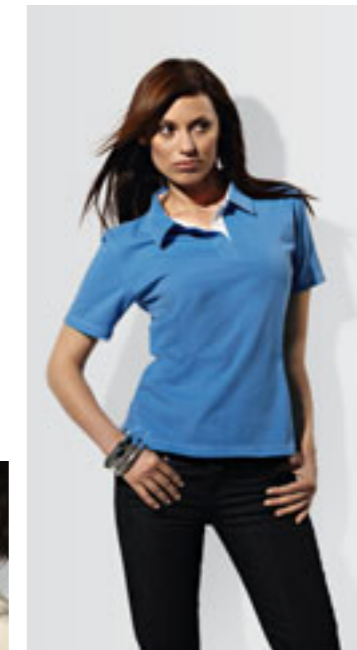



BMW JOY Rucksack. Joy on the go: this contemporary rucksack combines an appealing shape with plenty of functionality. Take the carry strap with integrated mobile phone holder, the two fleece-lined multimedia sections with watertight zip, the adjustable across-body strap and practical neoprene handles, and the special compartments for documents, pens, flight tickets and magazines. A large, fleece-edged open section and the insulated, watertight drinks compartment provide generous storage options. The padded side pockets can fit all standard 17" laptops and accessories. And the padded back area provides even more carrying comfort thanks to a special airflow system. To add some visual joy, the rucksack was kitted out with a fashionable BMW pin, a "JOY TRAVELS IN STYLE" tag and our JOY wordmark at the front.

Black
80 22 2 179 735



BMW JOY Trolley Bag. The it bag for overnight stays: with its three roomy outer pockets, this trolley bag offers enough storage for everything you need for a weekend trip and has a zip to further expand its capacity. It fits into every overhead compartment, thus fulfilling all the requirements for the ideal piece of carry-on luggage. The adjustable telescopic handle (2 settings), the noise-cancelling wheels, the handy carry handles and elastic straps in the inner compartment add to the positive first impression and ensure a stress-free journey. And our JOY manifesto on the lining and the "JOY TRAVELS IN STYLE" tag will remind you that joy is your constant companion.

Black
80 22 2 179 734



BMW JOY Messenger Bag. Travel in style: in addition to top-class workmanship, the padded laptop bag impresses with a handy organiser compartment, a dedicated slot for flight tickets and a mobile phone holder on the side. Suitable for all standard 17" laptops. With adjustable, padded shoulder strap and retractable handle. The BMW logo, "JOY TRAVELS IN STYLE" tag and JOY wordmark on the side ensure that the messenger bag is an attraction in itself.

Black
80 22 2 179 736





Garment Bag. The most stylish way to carry off a suit: this elegant garment bag is made of water-repellent polyester. Main section with five additional zip compartments (one with mesh). Four shoe pockets and a fastening system for hangers. Interior with elastic strap and cover with snap buttons. Large zip pocket at the front for easy access to important documents. Two handy side clips to keep the bag securely closed. Adjustable strap and carry handle for convenient transport. Dimensions when closed (L x W x H): 54 x 56 x 20 cm
Dimensions when open (L x W x H): 108 x 56 x 10 cm
Weight: 3.0 kg

Black/Grey
80 22 2 166 598



Travel bag with trolley function. Finally you can travel in style, with this spacious travel bag made of water-repellent polyester. Large compartment with rip closure. Two elastic straps hold clothes or documents securely in place. Zip pocket at the front with two mobile phone holders, two PDA compartments and one open all-purpose slot. Two side zip pockets (one of them a shoe compartment, the other with an extra inner compartment). Bottom with two scuff-protector strips. Three carry handles, lengthwise and widthwise. Retractable telescopic trolley handle and two wheels on ball bearings. Dimensions (L x W x H): 69 x 34 x 33 cm
Dimensions of telescopic trolley handle (W x H): 15 x 102 cm
Weight: 3.2 kg

Black/Grey
80 22 2 166 604



Boardcase. Goes wherever you go: robust boardcase made of water-repellent polyester. Interior with two zip pockets and elastic straps for safe transport of suits and business outfits. Two protective strips on the back, corners with scuff guards. Two outer zip pockets. Two carry handles, retractable telescopic trolley handle, and two wheels on ball bearings. Dimensions (L x W x H): 35 x 54 x 20 cm
Dimensions of telescopic trolley handle (W x H): 15 x 100 cm
Weight: 4.4 kg

Trolley Bag. Trip too short for a suitcase, but too long for a rucksack? This trolley bag made of water-repellent polyester is your ideal companion. The generous main compartment features straps and two zip compartments to secure your garments and documents. The lid holds a suit compartment with elastic straps. Two protective strips on the back provide additional safety. Corners with scuff guards. Two zip pockets for keys, boarding cards and snacks. Two carry handles, retractable telescopic trolley handle, and two wheels on ball bearings. Dimensions (L x W x H): 47 x 66 x 31 cm
Dimensions of telescopic trolley handle (W x H): 15 x 102 cm
Weight: 5.6 kg

Boardcase, Black/Grey
80 22 2 166 595

Trolley Bag, Black/Grey
80 22 2 166 596



Sports Bag. That's how elegant sporty can be: handy sports bag made of water-repellent polyester. The main compartment with integrated zip pocket offers plenty of room for sports and leisure clothing. Two outer side pockets and one front pocket. Comfortable to carry thanks to adjustable shoulder strap, two side carry handles and one main carry handle. Dimensions (L x W x H): 54 x 31 x 32 cm
Weight: 1.4 kg

Black/Grey
80 22 2 166 603



Rucksack. The perfect companion for travel, short trips and meetings. Laid-back rucksack made of water-repellent polyester, with handy zip pocket, comfortable main compartment and a slot compartment with protective lining. Two padded, adjustable carry straps and supportive padding at the back ensure superior carrying comfort. Handy carry loop. Dimensions (L x W x H): 32 x 41 x 14 cm
Weight: 0.8 kg

Black/Grey
80 22 2 166 602





Travel Bag. Almost too good to only use for travelling. This stylish bag will make arriving at any destination a pleasure. Sophisticated design elements such as the combination of premium leather and contemporary nylon give it a look all its own, expressing an understated elegance and dynamism. The shoulder strap, padded leather carry handles and rubberised zip are always at the ready. Just like your maps and pens for which special interior compartments are provided. Another highlight in the interior: the quality leather label with its tonal BMW pin. Design element and tonal BMW pin on the front.
Dimensions (L x W): approx. 65 x 34 cm

Black
80 22 2 147 077



Business Bag. Business trips are all about being well organised, and this lightweight, handy business bag represents the perfect blend of functional accessory and style statement. Even the bag's closure combines an elegant design with down-to-earth functionality. The contemporary leather and nylon combination and top-class workmanship show immediately where you're headed: for Business Class. The interior features various compartments for maps and writing utensils as well as a premium leather patch with BMW pin. With leather carry handles and shoulder strap.
Dimensions (L x W): approx. 50 x 28 cm

Black
80 22 2 147 076



Walking-Stick Umbrella. Elegant umbrella with lightweight aluminium and fibreglass frame. Handle with embossed leather insert in special BMW design. Fabric: 100% Teflon-coated polyester.

Black
80 23 0 305 902



Pocket Umbrella. Practical pocket umbrella for when you're out and about. Sophisticated automatic opening/closing system. Handle in special BMW design with leather insert. Protective sheath included. Fabric: 100% Teflon-coated polyester.

Black
80 23 0 305 901



Document Bag. Business meets pleasure: this stylish document bag rounds off your sophisticated appearance. The black nylon and leather combination combines design and functionality. The bag provides space for important documents and comes with a removable compartment for laptops of up to 15" in size. Various interior compartments keep maps and pens tidy. Leather carry straps and a black shoulder strap for increased comfort. Tonal BMW pin on the outside and leather label on the inside.
Dimensions (L x W): approx. 40 x 8.5 cm

Black
80 22 2 147 075



Shopping Bag. This stylish shopping bag is made for the city: not just a perfect shopping companion, it also attracts admiring glances thanks to sophisticated details such as an elegant design element and the tonal BMW pin. Combining fashionable nylon and high-quality leather, this bag will accommodate all your daily essentials. The removable black carry strap and black leather handles ensure that you can navigate the city in perfect comfort. And if you prefer not to carry it yourself, you can attach the shopping bag to a trolley.
Dimensions (L x W): approx. 65 x 34 cm

Black
80 22 2 148 849



BMW COLLECTION
BMW M COLLECTION
BMW BIKES & EQUIPMENT
BMW KIDS' COLLECTION
BMW MINIATURES
BMW YACHTSPORT COLLECTION
BMW MOTORSPORT COLLECTION
BMW GOLFSPORT COLLECTION



Large Travel Bag. Sporty, casual, and fuss-free. You will not want to miss this travel bag – whether it's on holidays, business trips, or in your everyday life. This sturdy bag has a generous luggage compartment which accommodates even larger items gracefully. The bag is cut from a single piece of coated polyester that is subsequently folded and welded. Other useful features: it can be folded to save space and is lightweight, moisture-resistant and easy to wipe clean. The separate carry strap attaches quickly to the specially designed clamp closure. Flag label with tonal BMW pin on the side. Dimensions: 75 x 50 x 33 cm

Red
80 22 2 147 291



Small Travel Bag. This smaller, handy variant of the Travel Bag is the perfect companion for shopping, sports, short trips and weekend adventures. Functional zips that go all the way to the bottom make for convenient storage. The empty bag can be folded to save space. It owes its distinctive shape to the innovative way in which the coated polyester is processed: the bag is cut from a single piece of material and subsequently folded and welded. It is lightweight and sturdy, moisture-resistant and easy to wipe clean. Separate carry strap, flag label with tonal BMW pin on the side. Dimensions: 60 x 34 x 29 cm

Red
80 22 2 147 292



Notebook. Incomparably useful, unmistakably BMW: covered in flexible and easy-care material, these premium BMW notebooks are perfect companions for work, leisure, and travel. The generous A4-size version offers plenty of space for notes, ideas or illustrations, and the handy A5-size model is the ideal notebook for people on the move. With tonal BMW pin.

Red, A5 size
80 22 2 149 635



Notepad. Small enough to fit into almost every pocket, it always comes in handy. The reporter-style BMW notepad lets you jot down your thoughts wherever and whenever you feel like it. Covered in easy-care, flexible material. With tonal BMW pin.

Red, A7 size
80 22 2 149 634



Ladies' Leather Wallet, horizontal. A stylish investment: this sophisticated wallet is made from especially soft and resilient leather and provides enough storage to keep money matters neat and organised. The two-part coin section has a quick fastener and a zip. Numerous slots provide ample space for credit cards, driver's licence and other documents. Material: 100% calf leather.

Black
80 21 2 179 723



BMW Ladies' Wallet. Space galore: this high-quality ladies' wallet is fashioned from soft leather. In addition to a roomy coin section, it has six credit card slots, five extra slots, a two-part notes compartment at the back and a hidden compartment under the coin section. There's no better way to organise your finances. Material: 100% calf leather. Dimensions: approx. 11.5 x 2.4 x 10 cm

Black
80 21 2 179 724



Men's Wallet. Carefully crafted, elegant leather wallet with roomy coin section, eight slots for credit cards, four slots for driver's licence and documents, and two notes compartments. The especially soft and durable leather will make reaching for your wallet something to look forward to. Material: 100% calf leather. Dimensions: approx. 12.5 x 2.3 x 9.6 cm

Black
80 21 2 179 721



Men's Wallet, flat. This elegant, carefully crafted leather wallet offers space for up to 15 credit cards and three document cards. It also has two notes compartments. The design offers quick access to five compartments while the others are protected on the inside of the wallet. Material: 100% calf leather. Dimensions: approx. 12.5 x 1.7 x 9.6 cm

Black
80 21 2 179 722



Clip-on Holder. Functional, well-designed holder with space for personal utensils that you would not want to travel without. The holder comes with a clip-on metal carabiner to attach to your business bag or travel bag. BMW pin on the outside. Material: leather/nylon.

Deep Orange
80 21 2 147 237

Black
80 21 2 147 078



Notepad Folder. Whether you're on the move or in the office – these stylish, real-leather folders will help you keep your notes tidy and protected. Available in Black or Deep Orange. Format: A5 and A7. Paper notepad included. BMW pin on the outside.

Deep Orange, A5 size
80 21 2 147 098

Black, A7 size
80 21 2 147 241

Deep Orange, A7 size
80 21 2 147 101



BMW Classic Men's Watch. The stylish timepiece: this classic men's wristwatch with its brushed stainless steel case and BMW logo on the watch face boasts a wealth of sophisticated features. These include a Swiss quartz movement, date display as well as water-resistance up to 10 atm. A laser-engraved BMW logo on the back, a black sunburst watch face and a black leather strap with stainless-steel closure ensure that this watch is bang on time in the looks department.

Black leather
80 26 2 179 741

BMW Classic Ladies' Watch. Laidback and elegant: this beautiful ladies' watch with its 30 mm stainless steel case, stylish leather strap and black watch face does not only display the time and date, but also shows off its owner's sense of style. With its laser-engraved BMW logo on the back, water-resistance up to 10 atm and precise Swiss quartz movement, this watch not only looks good, it is also incredibly hard-wearing.

Black leather
80 26 2 179 742



BMW Metal Sunglasses. A sight for sore eyes: these sunglasses are both fashionable and functional. This is ensured by the silver frame and shatterproof green lenses as well as 100% UVA, UVB, and UVC protection up to 400 nm, and the laser-engraved BMW logo on both temples. Cleaning cloth included.

80 25 2 179 172

BMW Quartz Chrono Metal Men's Watch. Ahead of its time: this massive men's chronograph with its 40 mm brushed stainless steel case, Swiss ETA movement with date display, dedicated second display, 30-minute display and 0.1-second stopwatch feature is setting standards for both form and function. The sophisticated silver watch face has a coloured BMW logo. Luminous hands and an engraved logo on the back add the finishing touches. The stainless-steel strap with butterfly clasp is adjustable. This chronograph is water-resistant up to 10 atm. And 100% stylish.

Stainless steel, White
80 26 2 179 743



Ladies' Quartz Chronograph. Timeless beauty: this quartz chronograph with a white face and adjustable metal bracelet combines casual design and classic elegance. With a coloured BMW logo, date display and Swiss precision quartz movement. The high-quality stainless steel case has the BMW logo lasered onto the reverse.

Stainless steel, White
80 26 2 159 892



BMW Titanium Sports Style Sunglasses. These high-quality titanium glasses will please you at first sight. Features include a silver-coloured, extra lightweight frame, shatterproof blue-tinted lenses, laser-engraved BMW logo on both temples and an elegant, sporty design. 100% UVA, UVB, and UVC protection up to 400 nm ensures you can enjoy the sunshine without regrets. Cleaning cloth included.

80 25 2 179 173



BMW Quartz Chrono Men's Watch. Joy at first sight: this sporty and elegant men's chronograph has a premium brown strap made from crocodile-print calf leather and a contrasting white watch face with BMW logo. From the outside, this watch also impresses with a 40 mm stainless steel case, and a laser-engraved BMW logo on the back. The inside boasts technical features such as a Swiss movement, a date and a second display, stopwatch function, 30-minute display, timer, and water-resistance up to 10 atm.

Brown
80 26 2 179 745

BMW Quartz Chrono Men's Watch with Leather Strap. Timeless beauty: the men's chronograph with its premium grained leather strap in matt black and black watch face with BMW logo has a 40 mm stainless steel case with a laser-engraved BMW logo on the back. Technical highlights such as a Swiss ETA movement, a date and a second display, stopwatch function, 30-minute display and timer, make it an ideal companion for almost any situation – and not just on dry land, thanks to a water-resistance up to 10 atm.

Black
80 26 2 179 744



BMW Titanium Sports Sunglasses. Just right for the trend-aware sportsman: these lightweight, black titanium glasses are not only highly functional, but also easy on the eye. This is due to the black polarised lenses which minimise glare and reflections. Your eyes will get less tired when looking at flat, reflective surfaces like water or metal and will not have to adapt as much to changing lighting conditions. The result: increased safety thanks to excellent glare protection, enhanced colour perception, and a pair of sunglasses which makes a sportsman see well and look good. 100% UVA, UVB, and UVC protection up to 400 nm. Cleaning cloth included.

80 25 2 179 174



Men's Sports Chrono. Sizeable, sporty chrono watch with 44 mm stainless steel case. Water-resistant up to 10 atm. Black and white face with raised BMW logo. Swiss precision quartz movement. Mineral glass for scratch-resistance. With stopwatch function, date display and small second display. Sturdy stainless steel strap with metal clasp. Laser-engraved BMW logo on the back.

Stainless steel, Black
80 26 2 147 052



Self-Coloured Tie With Pattern, across.

Blue Grey 80 72 0 434 302
Silver 80 72 0 434 300
Medium Grey 80 72 0 434 301



Self-Coloured Tie With Pattern, diagonal.

Red 80 72 0 434 305
Dark Blue 80 72 0 434 304
Light Blue 80 72 0 434 303



Pashmina. This elegant pashmina scarf made of cashmere and silk will ensure that you will be as stylish as ever on cold days. The material mix keeps you snug and warm and is very comfortable to wear.
 Material: 60% cashmere, 40% silk.
 Size: 100 x 200 cm



Light Blue
 80 72 0 434 318

Silver
 80 72 0 434 317

Tie. Premium silk tie, self-coloured, with various woven patterns, classic diagonal stripes or a kidney grille design.
 Material: 100% Italian silk.



Striped Tie.

Dark Blue
 80 72 0 434 308
Light Blue
 80 72 0 434 309



Silk Foulard. Goes with every outfit, and no wardrobe is complete without one: the diamond-shaped silk foulard with contrasting edging.
 Material: 100% silk.
 Size: 90 x 90 cm

Dark Blue / Red
 80 72 0 434 316
Light Blue / Silver
 80 72 0 434 314



Tie With BMW Kidney Grille, patterned.

Blue / Light Blue 80 72 0 434 311
Red / Light Blue 80 72 0 434 312
Light Blue / White 80 72 0 434 313



Tie With Tyre-Thread Pattern.

Silver 80 72 0 434 306
Light Blue 80 72 0 442 853
Blue 80 72 0 434 307

Silk Foulard – Exclusive BMW Kidney Grille Design. Wear a piece of history: this silk foulard features an exclusive BMW kidney grille design. The foulard's decorative pattern echoes the kidney grille shapes of BMW automobiles from various eras, creating an elegant piece of brand history.
 Material: 100% silk.
 Size: 90 x 90 cm

White / Light Blue
 80 72 0 434 319



BMW COLLECTION
 BMW M COLLECTION
 BMW BIKES & EQUIPMENT
 BMW KIDS' COLLECTION
 BMW MINIATURES
 BMW YACHTSPORT COLLECTION
 BMW MOTORSPORT COLLECTION
 BMW GOLFSPORT COLLECTION



BMW X1 Key Ring Pendant. A true X1: just like the vehicle, this key ring pendant is a real looker. This is ensured by the elegant finish of the X1 wordmark and the quality metal material. With BMW logo.

80 23 2 156 846



BMW 5 Series Gran Turismo Key Ring Pendant. Goes perfectly with the 5 Series Gran Turismo – and with every individualist. The key ring pendant with the “GT” wordmark is made from quality metal and features a BMW logo.

80 23 2 157 673



Key Ring Pendant “Design”. Form meets function: brushed die-cast key ring pendant with BMW logo epoxy pin. Dimensions: approx. 8.8 x 2.4 cm

80 56 0 443 282



Key Ring Pendant “Square”. A real door opener: the stylish key ring pendant in matt die-cast with BMW emblem. The lever mechanism facilitates opening and closing the ring and ensures that keys stay safely in place. Dimensions: approx. 5 x 2.9 cm

Matt Silver
80 56 0 443 278



Key Ring Pendant “Function”. A design piece you can take with you: this clever key ring pendant is made of brushed die-cast and features black plastic applications along its sides. With BMW logo epoxy pin. Dimensions: approx. 7.3 x 2 cm

80 56 0 443 284

BMW Logo Key Ring Pendants. High-gloss nickel-plated pendants with three-colour BMW logo.

80 23 0 444 663

80 23 0 305 911

JOY Key Ring Pendant. Enjoy the small things in life: this beautifully styled key ring pendant made of quality metal opens doors for friends of good design.

80 23 2 179 082

BMW Logo Key Ring Pendants. High-gloss nickel-plated pendants with three-colour BMW logo.



BMW 1 Series
80 23 0 305 914



BMW 3 Series
80 23 0 136 287



BMW 5 Series
80 23 0 136 288



BMW 6 Series
80 23 0 305 915



BMW 7 Series
80 23 0 136 289



BMW 7 Series
80 23 0 149 151
(from 2002 model onwards)



BMW Z3
80 23 0 432 391



BMW Z4
80 23 0 406 871



BMW X3
80 23 0 305 912



BMW X5
80 23 0 305 913



BMW X6
80 23 0 444 662

BMW COLLECTION
BMW COLLECTION
BMW BIKES & EQUIPMENT
BMW KIDS' COLLECTION
BMW MINIATURES
BMW YACHTSPORT COLLECTION
BMW MOTORSPORT COLLECTION
BMW GOLFSPORT COLLECTION



Flag Label Pencil. Stylishness writ large: handsome pencil in Black or Silver, with a woven BMW label. Material: wood, textile. Length: approx. 17.5 cm

Silver
80 56 0 444 593

Black
80 56 0 444 559



Writing Utensil Holder. An elegant accessory that will always attract attention. Made from the finest, carefully selected calf leather. Fold with concealed magnetic closure. Suitable for two writing utensils. Available in Black and Deep Orange, according to your preference. Dimensions (L x W x H): approx. 5.3 x 2.5 x 17.2 cm

Black leather
80 21 2 148 848

Deep Orange leather
80 21 2 147 061



BMW Badge. Handsome BMW metal badge with epoxy dome surface. With handy butterfly closure and cardboard backing. Diameter: 1.0 cm

80 56 0 444 572



Mobile Phone Strap. Always well connected: the small, coloured BMW pin can easily be attached to any mobile phone. Also doubles as a key ring pendant.

80 23 2 159 690



BMW USB Stick, 8 GB. Elegant USB stick in the shape of a BMW vehicle key. Press the luggage compartment button to extend or retract the USB connector. Many uses, for example via the BMW USB Audio socket or the USB port of modern navigation systems.

65 41 2 179 284



Fountain Pen. This tasteful, contemporary-styled fountain pen puts the fun back into writing by hand. It comes with a screw cap and an exquisite leather insert. The premium wing nib glides effortlessly across paper. Refills with standard large-size cartridges (except Lamy) or the supplied converter. BMW logo on the cap.

Black leather
80 24 0 395 343



Ballpoint Pen. Discover how pleasurable writing by hand can be: this exquisite ballpoint pen with its fine leather insert has a superb ergonomic design. Twist mechanism at the tip, standard Euro refills (except Lamy). BMW logo.

Black leather
80 24 0 395 344



BMW Pin. For those who value pinpoint precision: beautiful BMW pin with safety cap and epoxy dome surface.

80 56 0 443 263



Silverside Notebook. A shining example: this bound notebook combines glamour with sturdiness. The solid hardcover is offset by the sophisticated silvered edges. Just right for your brilliant ideas. With embossed BMW logo on the lower right. 160 pages, squared. Dimensions: approx. 10.9 x 15.2 cm

80 56 0 444 565



Notepad Book. Don't look, find: the Notepad Book, with colourful marker strips in five colours and sticky notes in two different sizes, all with the BMW logo, helps you organise your thoughts. Presented in a robust hardcover that also features the BMW logo.

80 23 2 163 471



Speedometer Notepad Cube. Ideal for important notes. The speedometer design attracts attention at any workplace. Bottom with woven BMW label.

80 56 0 444 562



Lanyard "Rectangular". The especially large weave of the nylon strap makes this stylish lanyard particularly durable. With rectangular metal buckle and sturdy metal ring closure. With BMW logo epoxy pin. Dimensions: approx. 43.5 x 1.5 cm

80 56 0 443 299



Tumbler "Design". BMW tumbler in a timeless design. High-quality porcelain tumbler with plastic sleeve for improved grip. Height: approx. 130 mm, diameter: approx. 92 mm

Dark Blue
80 22 2 156 342

Light Blue
80 22 2 156 343



Thermo Mug. Large insulated mug with brushed steel sleeve and handy plastic lid for hot drinks on the go. Capacity: 0.4 l

80 56 0 443 336

BMW COLLECTION
BMW M COLLECTION
BMW BIKES & EQUIPMENT
BMW KIDS' COLLECTION
BMW MINIATURES
BMW YACHTSPORT COLLECTION
BMW MOTORSPORT COLLECTION
BMW GOLFSPORT COLLECTION

BMW M COLLECTION.

Exceptional dynamics, superior technology and authentic motorsport appeal are embodied by one perfect letter: M. It is the most powerful letter in the world. The BMW M automobiles carrying this mark of distinction are the epitome of top-class performance, sportiness and everyday usability. Maximum driving pleasure. The appreciation of select materials. And the joy of the extraordinary. This is what the entire M Collection is about. Even if you are not currently on the road: our M Collection will keep you in the driver's seat. Welcome aboard.

DRIVING IN THE FAST LANE.



State-of-the art materials.

The pocket lining and neck tape of all garments have a distinctly sporty carbon look.



Sporty design.

From jacket to wallet, this entire collection features red design elements which give it its sporty, dynamic appeal.

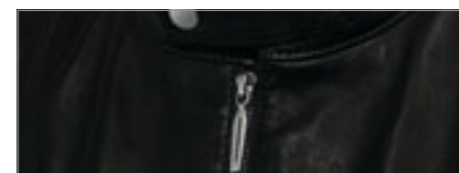

Dynamic performance.

M epitomises pure driving enjoyment. Which is why we designed the zips of all M Collection garments in the shape of the original BMW M double spoke. They are also made of advanced titanium.



M Men's Leather Jacket. Sophisticated can be laidback: handmade black leather jacket with red lining in a 1,000-piece limited edition. Stylish features such as zippered sleeves, a carbon-style neck tape, and the slanted zippered breast pockets make this jacket enticing indeed. The fashionable leather stand-up collar is lined with a ribbed fabric collar for extra comfort. Check the neck area for your garment's unique serial number. This jacket oozes effortless style. Handmade in Germany. 100% leather.

Black
S-XXL 80 11 2 154 895-899

M Men's Fan T-Shirt (p. 61).

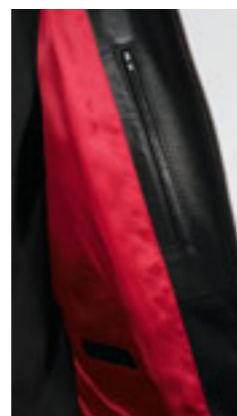

M Men's Nylon Jacket. Allrounder for BMW M fans: this sporty jacket is made of wind and water-repellent nylon and features a trendy stand-up collar as well as one inner and two outer pockets. The coloured BMW M print on the breast pocket, the trademark BMW M stripes across the shoulders and sleeves, the BMW logo at the neck and the carbon design elements convey classic, dynamic motorsport style – while attracting admiring glances. Material: 100% nylon.

Anthracite
S-XXL 80 12 2 166 201-205
XXXL 80 12 2 181 582

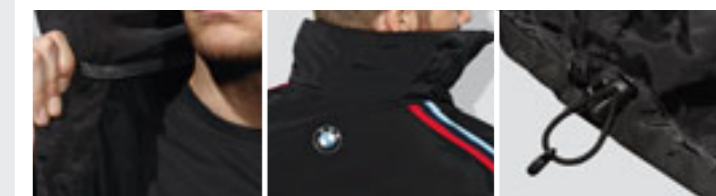

M Men's Jacket. Whether you're behind the wheel or not – the M Jacket will make you feel good. This wind and water-repellent garment is made from breathable Soft Shell fabric and features dynamic red piping and red lining. Short length for optimum comfort while driving. Titanium zip in the shape of an M double spoke. Embroidered with the BMW M logo. Material: 100% polyester.

Anthracite
S-XXL 80 12 0 446 801-805

M Men's Polo Shirt (p. 62).



M Ladies' Jacket. This wind and water-repellent garment is made from breathable Soft Shell fabric and features a tall stand-up collar, dynamic red piping and red lining. Short length for optimum comfort while driving. Titanium zip in the shape of an M double spoke. Embroidered with the BMW M logo. Material: 100% polyester.

Anthracite
XS-XL 80 12 0 446 841-845



M Men's Fan T-Shirt, Limited Edition. This is what passion looks like. The special design by K. J. Elmitt, exterior designer of BMW M vehicles, speaks for itself: the anthracite-coloured T-shirt with its sophisticated details doesn't just look good on M drivers. The powerful, exclusive studded look and specially finished materials fuse technology and fashion. The pleasantly soft fabric completes the fan package. Material: 100% cotton.

Anthracite
S-XXL 80 14 2 154 905-909



M Ladies' Studded T-Shirt. No T-shirt, but a statement – designed by K. J. Elmitt, exterior designer of BMW M vehicles. The large studded logo across the chest is not the only visual delight this fashionable, tailored shirt has to offer. It also features a carbon-style neck tape and BMW M stripes on the seam. Perfect for all current and future BMW M fans. Material: 95% cotton, 5% elastane.

Anthracite
XS-XL 80 14 2 166 216-220
XXL 80 14 2 181 585



M Ladies' Sequined T-Shirt. Featuring a large M logo in shiny sequins – the perfect combination of sportiness and style – designed by Martina Bachmann, Head of BMW M Interior Design. The BMW M stripes below the seam, the carbon-style neck tape and the eye-catching raglan sleeves provide additional, trademark M highlights. The tailored fit and especially soft fabric make this shirt a must-have for all ladies who like to show their passion for dynamism. Material: 95% cotton, 5% elastane.

Anthracite
XS-XL 80 14 2 166 221-225
XXL 80 14 2 181 586



M Men's Fan T-Shirt. Become a fan: this T-shirt is irresistible, thanks to the powerful colour combination of the printed M logo. This is what makes the Fan T-shirt perfect for events. Material: 100% cotton.

White
S-XXL 80 14 2 158 074-078



M Men's Fan T-Shirt. This sporty round-neck T-shirt features a large, coloured BMW M logo across the chest. The sporty carbon-style necktape makes for a dynamic look, the material is exceedingly comfortable and the shirt itself radiates pure sporting appeal. Material: 100% cotton.

Anthracite
S-XXL 80 14 2 166 206-210
XXXL 80 14 2 181 583



M Men's T-Shirt. This is a real eye-catcher, and not just because of the colour. The sporty red men's T-shirt features a few surprising, original details. The right sleeve is embroidered with a trademark M spoke, and there's also a BMW M logo embroidery on the back of the right shoulder. Equally stunning: the contrasting seams add to the dynamic look. Material: 100% cotton.

Red
S-XXL 80 14 2 154 915-919



M Cap. Fashionable baseball cap for ladies and gents. Peak with carbon-style underside, exterior with embroidered M double spoke and BMW M logo.

80 16 2 182 418



M Logo Cap. Hot and fast on or off the track: red lining and embroidered M logo at the front left.

80 16 2 182 419



M Men's Longsleeve. High performance meets everyday usability. This sporty men's longsleeve convinces with dynamic, slightly darker seams and various carbon-style design elements and contrasting splashes of red. With embroidered coloured contours of the BMW M logo across the chest and a trademark BMW M spoke on the right sleeve. Especially soft material finish.
Material: 95% cotton, 5% elastane.

Anthracite
S-XXL 80 14 2 166 211-215
XXXL 80 14 2 181 584



M Men's Carbon Tie. Sophisticated carbon-style silk tie with a woven BMW M logo at the front and back. Another perfect piece from the BMW M Collection for a classic yet contemporary look.
Material: 100 % silk.

Anthracite
80 16 2 179 762

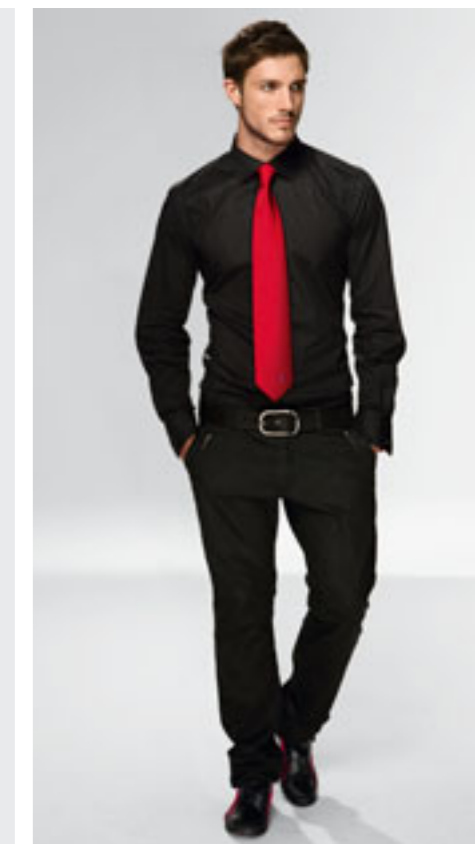

M Tie. Adds a special note to any business meeting and to the entire M Collection: the BMW M Tie, finished to the highest standard and made of pure silk. With anthracite interior finish and woven coloured BMW M logo on the front and back.
Material: 100% silk.

Red
80 16 2 154 925



M Men's Polo Shirt. This classic model will fit right in with your wardrobe: elegant, sporty polo shirt with contrasting seams for a dynamic look. Trendy three-button placket. Lavishly embroidered with the trademark M double spoke and BMW M logo.
Material: 100% cotton.

Anthracite
S-XXL 80 14 0 446 816-820

White
S-XXL 80 14 2 148 261-265



M Sports Chronograph. Sporty chronograph watch with brushed stainless steel case. The face has a modern carbon styling and raised coloured BMW M logo. Swiss precision quartz movement. Water-resistant up to 10 atm. Mineral glass for scratch-resistance. With stopwatch function, date display and small second display. Anthracite leather strap with metal clasp. Laser-engraved BMW logo on the back.

80 26 2 147 048



M Watch. Contemporary, sporty watch with high-quality stainless steel case, modern black rubber strap and red hands. Scratch-resistant mineral glass, a Ronda Swiss movement and water-resistance up to 5 atm ensure lasting joy. The black display, which includes an M logo, also indicates the date and day of the week.

80 26 2 159 890



M Cabin Bag. The stuff of elegance: fabric cabin bag in subtle anthracite, with zip pulls echoing the original BMW M double-spoke design. Two inner pockets with a carbon-style look and four pen holders in red Alcantara. Padded carry straps and a comfortable shoulder carry strap with dynamic red stripes. With BMW M logo and BMW pin.
Dimensions (L x W): approx. 50 x 28 cm

Anthracite fabric
80 22 2 147 344

M Travel Bag. Turn packing your bags into bags of joy. This travel bag is made from an anthracite-coloured fabric and features a zip with the original BMW M double-spoke design. Two inner pockets with a carbon-style look and four pen holders in red Alcantara. Padded carry straps and a comfortable shoulder carry strap with dynamic red stripes. With BMW M logo and BMW pin.
Dimensions (L x W): approx. 65 x 34 cm

Anthracite fabric
80 22 2 147 066



M Sunglasses. These sporty M sunglasses have got it all. Take the contrasting red colour on the inside. Or the premium graduated grey lenses with UVA, UVB and UVC protection up to 400 nm. Or the laser-engraved BMW logo on both temples. Cleaning cloth included.

80 25 2 179 278



M Leather Wallet. Plenty of room for money matters, in keeping with your sporty style. Leather wallet with coin section in carbon styling, numerous card slots and generous notes compartment. Exterior in subtle anthracite, inside with fine red Alcantara piping. BMW pin on the inside, embossed BMW M logo on the outside.

Anthracite
80 21 2 147 063



M Belt. High-quality, adjustable belt with a trendy raw edge design. Inside with fine Alcantara insert. Understated anthracite on the outside, inside dyed in a dynamic red hue. Five holes for adjustment and metal buckle with engraved BMW M logo. Embossed BMW logo on the inside of the belt.
Dimensions (L x W): approx. 120 x 3.5 cm

Anthracite
80 21 2 147 062



M Umbrella. Reinforced carbon frame. Leather-covered handle with a red and black design. Teflon-coated polyester silk canopy. With printed BMW M logo.

80 23 2 147 074



M Cufflinks. These will make you want to wear a shirt more often: high-quality metal cufflinks with an embossed BMW M logo on the face.

80 23 2 147 071



M Pin Badge. Metal pin badge, with 3D curvature and coloured enamel. Attaches with a stick pin and round clutch.

80 23 2 152 291



M Metal Key Ring. Sporty key ring pendant in the shape of the original M spoke. Embossed BMW wordmark on the split ring. Embossed BMW M logo on the lower end.

Metal
80 23 2 147 070



M Carbon Key Ring Pendant. Premium carbon key ring pendant with coloured BMW M logo and high-quality split ring with flexible ball-bearing.

Carbon
80 23 2 179 083



M CFRP Key Ring Pendant. Carbon key ring pendant. High-gloss nickel plating with three-colour BMW M logo.

Carbon
80 23 0 305 916



M Leather Key Ring Pendant. Outside in anthracite leather, inside with red Alcantara trim. Split ring with various hooks and rings and an embossed BMW wordmark. BMW M logo tag on the main key ring.
Dimensions (L x W): approx. 28 x 1.8 cm

Anthracite leather
80 23 2 147 238

BMW BIKES & EQUIPMENT.

Whether you're going for a quick spin or a grand tour, exploring a forest trail or the local park – with BMW Bikes, it's not about where you're going, it's how you get there. To ensure that proverbial riding pleasure, our bikes benefit from our automotive expertise, our long-standing experience and, above all, our passion. The result are bikes that will always lead the field. With designs that perfectly combine form and function, using state-of-the-art components and hydroformed aluminium frames. And with one goal: to turn every metre of every ride into sheer joy.

BE THE ENGINE.



Contemporary Design.

Distinctive lines and an unmistakable design: all of our bikes have smooth-welded seams. Hydroforming technology allows for innovative frame shapes.



Intelligent details.

Cables for brakes and gear system are integrated within the frame, perfect suspension tuning, infinitely variable shocks. Looking for the best functionality? Just turn the page!



High-tech teamwork.

Turning every ride into an exciting event: the extremely precise interplay of premium components such as fully hydraulic disc brakes and Shimano gear selector systems.





BMW Mountain Bike Cross Country 2011. Whether your ride takes you along single track routes, serpentine tarmac or through a dried-up river bed, the sporty BMW Mountain Bike Cross Country excels on every surface and at every speed – thanks to its finely tuned suspension, high damping comfort and a frame geometry that allows for an athletic, inclined seating position. When going up a mountain you can count on this bike's excellent climbing ability. On downhill rides, its direct, sensitive steering characteristics ensure safety and agility. Premium components such as fully hydraulic disc brakes, a 30-speed Shimano XT shift system and a four-pivot rear suspension perfectly complement the hydroformed aluminium frame. The BMW Mountain Bike Cross Country can hold its own in any comparison. And on any terrain.

Weight: 12.9 kg. Aluminium frame (AL6061-T6), hydroformed and powder-coated. Sports suspension with lock-out suspension fork and four-pivot rear suspension with anti-bobbing technology.

Colour: Pearl White

Frame size:

M (47 cm, height 165–178 cm)	80 91 2 186 340
L (52 cm, height 174–190 cm)	80 91 2 186 341
XL (55 cm, height 183–195 cm)	80 91 2 186 342

- Frame:** Aluminium, full suspension, BMW design with integrated BMW logo, single-colour finish in Pearl White, rocker arm: Blue
- Fork:** Fox 32 FRL suspension fork, 100 mm travel
- Damper:** Fox Float RP2 BV air shock, 100 mm travel
- Handlebar:** Syntace Durafilite, Black
- Stem:** Syntace 149 Force, M: 105 mm L: 120 mm XL: 135 mm, Black
- Crank set:** Shimano XT 42/32/24, 170 mm arm
- Brakes:** Disc Brake Deore XT hydraulic disc brakes, 180/180 mm
- Wheel set:** Marvic Crosstrail
- Tyres:** Schwalbe Racing Ralph, 26 x 2.25, folding
- Shift system:** Shimano Deore XT, 30-speed
- Rear derailleur:** Shimano Deore XT
- Front derailleur:** Shimano Deore XT
- Shifter:** Shimano Deore XT
- Cassette:** Shimano XT, 11–34 teeth, 10-speed
- Chain:** Shimano Deore XT
- Saddle:** fi'zi:k Aliante Delta, Black
- Pedals:** Shimano PD-M540



BMW Mountain Bike Enduro 2011. When it gets down to the nitty gritty, there's only one person you can rely on: yourself. This is exactly how the BMW engineers felt when they decided to develop the articulating trekking stem for the BMW Mountain Bike Enduro themselves. Their premise: a mountain bike should adapt to its rider – not vice versa. An infinitely variable suspension with up to 140 mm of travel, a very upright seating position and a 30-speed Shimano XT shift system provide enhanced riding comfort. And ensure that you master every descent in perfect safety. Speaking of safety, the BMW Mountain Bike Enduro has been subjected to a comprehensive array of tests – like all bikes carrying the BMW name.

Weight: 14.8 kg. Monocoque frame consisting of two deep-drawn aluminium shells (AL6061-T6), robot-welded and powder-coated.

Colour: Glossy White/Green

Frame size:

M (45 cm, height 165–178 cm)	80 91 2 186 343
L (50 cm, height 174–190 cm)	80 91 2 186 344

- Frame:** Aluminium, full suspension, with 4-pivot rear suspension, BMW design with integrated BMW logo and BMW graphic styling, Glossy White/Green
- Fork:** Fox Talas 32 RL suspension fork, 140 mm travel
- Damper:** Fox RP2 BV, 145 mm travel
- Handlebar:** Syntace Durafilite MTB Lowriser
- Stem:** Syntace F149 Force
- Crank set:** Shimano, 170 mm arm
- Brakes:** Shimano Disc Brake Deore XT 180/180 mm
- Wheel set:** DT Swiss rims, DT Swiss E530
- Tyres:** Continental Mountain King 2.4" Supersonic
- Shift system:** Shimano XT 30-speed derailleur system
- Rear derailleur:** Shimano Deore XT
- Front derailleur:** Shimano XT FD-M770 E Type
- Shifter:** Shimano XT
- Cassette:** Shimano, 11–36 teeth, 10-speed
- Chain:** Shimano XT
- Saddle:** fi'zi:k Nisene Sport, Black/Green
- Pedals:** Wellgo dual-function pedals with click system

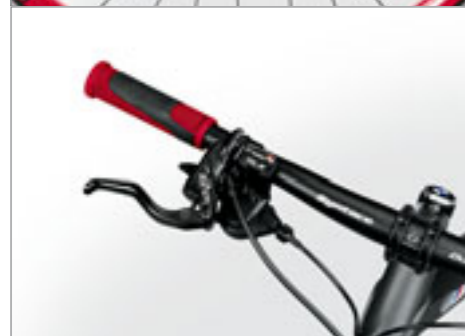

BMW M Bike 2010. A spectacular blend of high-tech, luxury and design: meet the BMW M Bike. Disc brakes and a sophisticated frame in Matt Anthracite with M logo, in combination with distinctive rims, grips and saddle inlay in the trademark BMW M red make this bike a true eye-catcher. The increased overall transmission ratio of the gear selector system ensures speedy acceleration. The fi'zi:k saddle with its premium leather and red inlay guarantees superior ride comfort and excellent support during trips into town or short overland rides. The Shimano SLX shift system is easy-going and robust, the Manitou Match suspension fork at the front is extremely durable and the disc brakes ensure safe stops. Just like the BMW M vehicles, the BMW M Bike embodies sportiness and exclusivity. It is available in a limited edition from June.

Weight: 12.9 kg. Aluminium frame (AL6061-T6), hydroformed and powder-coated.

Frame size:	Anthracite matt
M (46 cm, height 165–178 cm)	80 91 2 149 179
L (51 cm, height 174–190 cm)	80 91 2 149 180
XL (55 cm, height 183–195 cm)	80 91 2 149 181

(limited edition)

- Frame:** Aluminium, front suspension, BMW design with integrated BMW logo, cables partially integrated in head tube/down tube, Anthracite matt with BMW M logo
- Fork:** Manitou Match with lock-out function, aluminium steerer
- Handlebar:** Durafite 2014L, 600 mm, Matt Black
- Stem:** Syntace 149 Force, M: 105, L: 120, XL: 135, Black
- Crank set:** Shimano KRG SLX FC-M660, 26/36/48 teeth
- Brakes:** Hayes Stroker Ride set 140/160
- Hubs:** Shimano SLX, HB-M665, 32-hole, Centre Lock, Shimano SLX, FH-M665, 32-hole, Centre Lock
- Rims:** Rodi M380, 32-hole, with single eyelets, Red
- Tyres:** Conti Sport Contact Reflex 26x1.6
- Shift system:** Shimano SLX 27-speed
- Rear derailleur:** Shimano SLX RD-M662 Long Cage
- Front derailleur:** Shimano SLX FD-M660 Topswing, 31.8 mm
- Shifter/brake lever:** Shimano SLX SL-M660
- Cassette:** Shimano SLX HG-80, 11–32 teeth
- Chain:** Shimano CN-HG73
- Saddle:** fi'zi:k Tundra Red/Black
- Seatpost:** Kalloy SP-248, 27.2 mm, 350 mm
- Pedals:** Wellgo WBD-95B
- Additional equipment:** Carbon drinks bottle holder



BMW Cruise Bike 2011. The BMW Cruise Bike has instant appeal. Its unique aluminium frame owes its distinctive, unexpected design to hydroforming technology. All seams are smooth-welded and perfectly joined, adding to this bike's contemporary appearance. Emphasising the BMW Cruise Bike's laidback character, the cables for the brakes and gear system are hardly visible – in part, they even run inside the frame, which is available in White, White/Blue and Green/Black. The stem with its integrated BMW logo can be individually adjusted to perfectly match the height of the rider. Choice components like the telescopic fork, cantilever brake and Shimano Alivio 24-speed derailleur system complement the extraordinary design and underscore just how much riding pleasure this bike provides.

Weight: 13.9 kg. Aluminium frame (AL6061-T6), hydroformed and powder-coated, smooth-welded seams.

Frame size:	White	White/Blue	Green/Black
S (41 cm, height up to 168 cm)	80 91 2 186 324	80 91 2 186 328	80 91 2 186 332
M (46 cm, height 165–178 cm)	80 91 2 186 325	80 91 2 186 329	80 91 2 186 333
L (51 cm, height 174–190 cm)	80 91 2 186 326	80 91 2 186 330	80 91 2 186 334
XL (55 cm, height 183–195 cm)	80 91 2 186 327	80 91 2 186 331	80 91 2 186 335

- Frame:** Aluminium, front suspension, BMW design with integrated BMW logo, cables partially integrated in head tube/down tube
- Fork:** Suntour NCX-D suspension fork, 75 mm travel, integrated mudguard mounting
- Handlebar:** Humpert Moon Handlebar, aluminium
- Stem:** BMW Original Trekking (with adjustable angle) incl. BMW logo, S: 90 mm, M/L/XL: 110 mm
- Crank set:** Shimano Alivio, 42/32/22 teeth, 170 mm
- Brakes:** Shimano Alivio V-Brake
- Rims:** Rodi Airline Plus
- Tyres:** Schwalbe City Plus 50-559
- Shift system:** Shimano Alivio, 24-speed derailleur system
- Rear derailleur:** Shimano Alivio
- Front derailleur:** Shimano Alivio
- Shifter/brake lever:** Shimano Alivio
- Cassette:** Shimano Alivio, 11–32 teeth
- Chain:** Shimano Alivio
- Saddle:** Selle Royal Freccia
- Pedals:** Sport pedals with reflectors
- Additional equipment:** Bell, kickstand



BMW COLLECTION
BMW M COLLECTION
BMW BIKES & EQUIPMENT
BMW KIDS' COLLECTION
BMW MINIATURES
BMW YACHTSPORT COLLECTION
BMW MOTORSPORT COLLECTION
BMW GOLFSPORT COLLECTION



BMW Touring Bike 2011. 27 gears. And every single one of them ensures a great ride. The BMW Touring Bike with derailleur system combines contemporary design and optimum comfort. The use of hydroforming technology allows for the innovative, free-style frame design that makes this Touring Bike so distinctive. Premium components and equipment that meets all the requirements of the traffic authorities provide maximum safety at any time – whether you are riding along a country lane or a lone forest trail. The gel-cushioned saddle and ergonomically shaped comfort grips turn even a long journey into a comfortable affair. Because we believe that it should be the rider who decides on the length of a tour, not the bike.

Weight: 16.3 kg. Aluminium frame (AL6061-T6), hydroformed and powder-coated.

Frame size:	Glossy Chocolate
S (41 cm, height up to 168 cm)	80 91 2 186 336
M (46 cm, height 165–178 cm)	80 91 2 186 337
L (51 cm, height 174–190 cm)	80 91 2 186 338
XL (55 cm, height 183–195 cm)	80 91 2 186 339

Frame:	Aluminium, front suspension, BMW design with integrated BMW logo (powder-coated)
Fork:	Suntour NCX-D-LO Magnesium suspension fork with aluminium steerer, 75 mm travel with lock-out function, Black
Handlebar:	Humpert MTB low-riser, aluminium, 580 mm, Matt Black
Stem:	BMW Original Trekking, Matt Black (with adjustable angle), incl. BMW logo, S: 90, M/L/XL: 110 mm
Crank set:	Shimano Deore, 48/36/26 teeth, Hollowtech, length 170 mm
Brakes:	Shimano Deore
Hubs:	Shimano VR hub dynamo
Rims:	Rodi Airline Plus, burnished sides
Tyres:	Schwalbe City Plus
Shift system:	Shimano Deore, 27-speed derailleur system, Rapid Fire shifter
Rear derailleur:	Deore derailleur, Black
Front derailleur:	Shimano Deore
Shifter/brake lever:	Shimano Deore
Cassette:	Shimano Deore, 11–34 teeth
Chain:	Shimano Deore
Saddle:	Selle Royal Freccia Lookin 5207 HRC
Pedals:	Wellgo Aluminium Cage
Additional equipment:	Mudguards Silver/Black, lights including light sensor and stationary illumination, stand, pump, bell



Windbreaker 3 Jacket. This breathable, windproof and water-repellent jacket has a soft fleece lining that will keep you warm, making this an ideal garment for both bicycle and motorbike trips. Available at your BMW Motorrad partner.

XS–XXXL 72 60 7 717 256–262



BMW Cable Lock. Very light safety lock in BMW design, weighs 110 g, with 90 cm (36") steel cable and easily resettable, 4-digit combination. Ideal anti-theft protection for short stops.

80 93 0 441 472



Bike Saddlebag. For essential items such as the Micro Tool. Fitted with practical click'n'go holder, 3M reflector and safety blink clip.

80 92 0 421 825



Bike Rucksack. Innovative design, superb functionality. Comfortable shoulder and hip straps, versatile inner and outer pockets and foldaway helmet holder. Including drink system holder, 3M reflector and safety blink clip.

80 92 0 421 746



Battery Lights Set. Front and rear lights with universal attachment, suitable for all BMW Bikes. Adjustable front and side angles for optimum illumination. Brightness: 15 lux, light output: 30 hours. Charger and rechargeable batteries can be retrofitted.

80 92 0 431 648



Spiral Lock. Cable length: 200 cm, mounted on bike with universal holder.

80 92 0 427 707



Mudguards for MTB and Cruise Bike. Quick to mount on the front using snap-on attachment, and at the rear using the quick-release power strap, incl. anti-theft protection.

MTB, front 80 92 0 401 016

MTB, rear 80 92 0 401 040

Cruise Bike 80 92 0 401 015



Micro Tool. Lightweight, compact multi-tool with 18 functions. The Micro Tool comes with a neoprene bag that can be mounted under the saddle or stored in your pocket.

80 92 0 304 330



Fingerless Bike Gloves. Premium fingerless gloves with gel cushioning and reflective piping. The integrated gel pad prevents pins and needles and reduces vibration. RubberTech™ SafeGrip for improved grip on the handlebar. Designed to be easy to take off. Embossed logo on the right glove.

S–XL 80 92 0 442 229–232



Drinks Bottle and Holder. Lightweight, stylish aluminium bottle with a handy sports top. Guaranteed leak-proof, coated for food safety, holds hot and cold drinks (tested by the German RWTÜV technical safety agency). Capacity: 700 ml. Holder attaches to the Touring Bike, Cruise Bike, and MTB Cross Country.

80 92 0 414 346



Standard Bike Helmet. This sturdy helmet combines optimum safety and low weight. Individual ring system and various air vents. TÜV/CE-approved. Universal size from 54 to 60.

80 92 0 446 866



Bike Gloves. High-quality, ergonomic, breathable. The integrated gel pad prevents pins and needles.

S–XL 80 92 0 397 570–573

Trouser Strap. Protects the trouser leg from soiling and contact with the bicycle chain.

80 92 9 430 470

BMW COLLECTION
BMW M COLLECTION
BMW BIKES & EQUIPMENT
BMW KIDS' COLLECTION
BMW MINIATURES
BMW YACHTSPORT COLLECTION
BMW MOTORSPORT COLLECTION
BMW GOLFSPORT COLLECTION



BMW KIDS' COLLECTION.

With the BMW Kids' Collection we have developed products that grow up along with your kids. Like the BMW Kidsbike, which can be turned from a push-bike into a fully-fledged children's bicycle in just a few moments. Of course we haven't forgotten about joy, as evident in the JOY T-shirt from this year's collection with its "JOY NEVER SAYS NEVER" print, or the JOY promise (see page 36) on the inside at the back of the Kids' Hoody.

THE JOY HAS JUST BEGUN.



Safety first.

Reflective stripes on the rucksack for enhanced visibility, bikes with cushioned handlebars, TÜV-approved bike helmets matching the frame colour: when it comes to children, safety is our top priority.



Ergonomic details.

Before designing for kids, you have to observe them. How does a child move? How does it carry? Padded, adjustable carry straps and the ergonomically shaped saddle seat and handlebar of the Kidsbike provide answers.



Award-winning design.

The BMW Kidsbike won the EUROBIKE AWARD, the IF Product Design Award and the reddot design award for its unique combination of modern design and exceptional safety features.



Kids' JOY T-Shirt. Joy looks good on every kid! This dark blue kids' T-shirt with embroidered BMW wordmark on the sleeve shows why: the printed "JOY NEVER SAYS NEVER" motto at the front doesn't just sum up what childhood is about, the contemporary colour graduation also makes it look really good.
Material: 100% cotton.

Dark Blue
Size 104/116/128/146/152
80 14 2 166 842-846

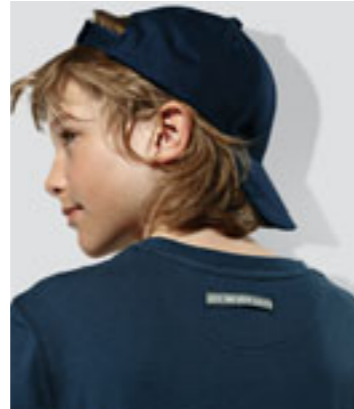

Junior Cap. A must-have for young BMW fans: the classic baseball cap is the smaller version of the unisex adult cap – for those family moments. The rip closure at the back ensures that the cap grows along with its wearer. Other highlights include the coloured BMW logo at the front and tonal sandwich piping.
Material: 100% cotton.

Dark Blue
80 16 2 166 855



Kids' JOY Hoody. Reasons to be cheerful: laidback blue hoody with lavish JOY appliqué in contrasting white at chest height and tonal embroidered BMW wordmark on the left sleeve. To make this piece extra cuddly and comfortable, we left off the cuffs on the sleeves and hem. The special fabric adds a warm and fuzzy feeling of happiness. Material: 100% cotton.

Blue
Size 116/128/140/152/164 80 14 2 166 847-851
Size 104 80 14 2 208 420



Pencil Case. Handy, stylish case for keeping writing utensils safe. Lining with decorative road map-style print and write-on name label area. Includes a metal carabiner clip to attach to the rucksack. Reflector strips on the outside. With coloured BMW pin.
Material: 100% polyester.

Orange
80 22 2 147 357

Notebook Sleeve. Handy notebook protector in A5 size. Lining with decorative road map-style print and write-on name label area. Includes a useful pen holder and squared notebook. Reflector strips on the outside. With coloured BMW pin.
Material: 100% polyester.

Orange
80 22 2 147 358

Blue
80 22 2 147 367



Rucksack. Stylish parents, stylish kids: comfortable, trendy rucksack with large main compartment and two outside compartments. Covered zips. Padded, adjustable carry straps and padded back area. Water-repellent coating and reflector strips on the outside. Includes a metal carabiner clip and sturdy carry handle. Embossed BMW wordmark on the carry handle. With coloured BMW pin.
Material: 100% polyester.

Orange
80 22 2 147 354

Blue
80 22 2 147 362

Bottle Holder with Drinks Bottle. Useful bottle holder with a metal carabiner clip that attaches to the rucksack. Includes a sturdy metal bottle (0.4 l capacity). Reflector strips on the outside. With coloured BMW pin.
Material: 100% polyester.

Orange
80 22 2 147 359

Key Ring Pendant. A fun item for kids: this key ring pendant comes with a compass, torch and magnifying glass. Handy: the key ring can be attached to the carabiner clip on the rucksack. With coloured BMW pin.
Material: 100% polyester.

Orange
80 23 2 149 063



BMW Kidsbike – a pushbike and bicycle, all in one. The BMW Kidsbike, featuring the trademark BMW design, offers one of the most advanced methods for teaching children how to ride a bike without stabilisers, enabling them to learn balance from an early age. This will not only make it easier for them to switch to actual cycling later on, they will also feel more secure from the start. The solid plastic pedals are fitted with reflectors and thus provide additional safety for small children. In addition to the complete pedal unit, each BMW Kidsbike also comes with a TÜV-approved bicycle helmet that matches the frame colour as well as a frame-mounted bag and a handlebar net. The ergonomically shaped saddle and handlebar ensure a comfortable seating position. The pushbike can easily be converted into a regular children's bicycle by fitting the pedal unit and chain supplied – and in no time, even smaller riders will be good to go. The Kidsbike is suitable for children from about 2½ years (without pedals) up to 6 years of age (with pedals).



Frame height: 36 cm
Seat height: 38–46 cm
Weight: 6 kg (without pedals)
 8 kg (with pedals)
Max. load: 50 kg

Blue 80 91 2 183 393
Red 80 91 2 183 395



The removable handlebar padding contains a mesh bag which can be used to transport small items like toy animals (toy not included).



The practical zippered bicycle bag fits perfectly in the space between the two sections of the bicycle frame. Easy assembly. Material: hard-wearing synthetics with appliqué BMW logo.



Included with the bike is a TÜV-approved children's bike helmet with a reflective surface in a colour matching the bike's frame as well as the complete pedal unit (consisting of 3 components).



BMW Cable Lock. Lightweight safety lock with 90 cm (36") steel cable, easy-to-set four-digit number combination and typical BMW design. Weight: 110 g

80 93 0 441 472

BMW COLLECTION
BMW COLLECTION
BMW BIKES & EQUIPMENT
BMW KIDS' COLLECTION
BMW MINIATURES
BMW YACHTSPORT COLLECTION
BMW MOTORSPORT COLLECTION
BMW GOLFSPORT COLLECTION



BMW Baby Racer II. The acclaimed classic in blue. A straightforward design with a comfortable seat for hours of driving pleasure. Special rubber tyres minimise noise and enable indoor use – even on parquet flooring. TÜV-approved. Suitable for ages 1½ to 3.

Dimensions (L x W x H): 70.5 x 32.5 x 40 cm
Wheelbase: 44 cm
Weight: 4.5 kg

Blue
80 93 0 006 909

BMW Junior Bike. The little big bike – a classic from the Kids' Collection. This unusual tricycle benefits from an individual design, with easy steering, large, noise-cancelling rubber wheels and optimised ergonomics for an ideal seating position. Thanks to its modular design, it is easy to take apart and transport. Suitable for ages 3 to 5.

Dimensions (L x W x H): 71 x 37.5 x 56 cm
Wheelbase: 48.5 cm
Weight: 4.5 kg

80 93 0 145 906



BMW Baby Racer II, Black. A favourite not just with the kids, but also with the neighbours: sporty Baby Racer with noise-cancelling rubber tyres. Exclusive design, quality workmanship. Comfortable, padded seat in red. Suitable for ages 1½ to 3. TÜV-approved.

Dimensions (L x W x H): 70.5 x 32.5 x 40 cm
Wheelbase: 44 cm
Weight: 4.5 kg

Black
80 93 0 446 003

BMW Snow Racer. Joy on the slopes: the perfect combination of riding pleasure, ergonomics, and safety make the BMW Bobby Bob a favourite in the snow – and the winner of a sleigh test conducted by German paper Bild am Sonntag and the TÜV Rheinland safety monitoring agency. The high-quality bobsleigh is made of cold-resistant, UV-resistant plastic. With its child-friendly features such as a super suspension for the steering axle, integrated horn, rustproof, replaceable runners, and ergonomically designed seat and handlebar, it will make you wish for longer winters. Suitable for ages 4 to 10, max. load 50 kg. Weight: 6 kg

80 93 0 493 884



BMW Baby Racer II Motorsport. For the racing drivers of tomorrow. With sports steering wheel, front spoiler, speedometer and rev counter, metallic-effect front and rear sections and BMW logo. Rubber tyres minimise noise. TÜV-approved. Suitable for ages 1½ to 3.

Dimensions (L x W x H): 73 x 32.5 x 40 cm
Wheelbase: 44 cm
Weight: 6.4 kg

Blue/White
80 93 2 163 090



BMW X6 Pullback. The 1:41-scale BMW X6 comes with a pullback mechanism enabling it to drive: simply place it on the ground, pull it back, and watch the BMW X6 strut its sporty stuff. Not just for kids' rooms.

BMW X6, 1:41
80 45 2 148 806



BMW Free Wheel Cars. If you want to give future BMW drivers a head start, the BMW 1 Series or BMW X6 Free Wheel Car might be just the thing. With its articulated wheels and 1:64 scale, it can explore every corner of your kids' room while teaching them about the fascinating world of BMW. For even more fun, the BMW 1 Series/X6 is compatible with the Maisto Free Wheel tracks.

BMW 1 Series, 1:64
80 45 2 149 158

BMW X6, 1:64
80 45 2 149 157



BMW 328 Roadster. A classic for little drivers. The timeless, unique design in white is by no means all the BMW 328 Roadster has to offer. This stylish car also makes your pulse race with its chrome-plated radiator grille and realistic wheel rims. It goes without saying that the Roadster is TÜV-tested and child's play to operate. Special rubber tyres ensure that this car can also be used indoors – without noise or concerns about potential damage to wood floors getting in the way of your driving pleasure. Pedal or electric versions available. Suitable for children aged 3 to 5.

Pedal version, White 80 93 2 149 183
Electric version, 6 V 80 93 2 149 182



BMW M6 Convertible. Detailed reproduction of the exclusive real-life model. Metallic blue paintwork. Original M front and rear bumpers, M6 wheels and M6 stickers on boot lid and front wings. Available with pedal or electric drive. With electric horn and speedometer. Material: painted steel frame, plastic containing no harmful substances. Max. load: 50 kg. For ages 4 to 7.

Electric version – adjustable operating speed: 8 km/h forward and 4 km/h reverse; running time: minimum 1.5 hours of continuous operation; charging time: approx. 15 hours; forward and reverse gears, foot brake, double brake function for added safety. Weight: approx. 17 kg.

Pedal version – easy-go pedal drive, adjustable seat position. Weight: approx. 10 kg

Pedal version, Blue 80 93 0 444 852
Electric version, 6 V 80 93 2 158 901



BMW 3 Series Convertible. Single-seater in two versions: as a pedal car with comfort pedals, or as an electric car (6V batteries) with automatic engine brake. Adjustable seat, rubber wheels. Made from tough plastic containing no harmful substances. Suitable for ages 3 to 5 approx.

Electric version – top speed of 4 km/h approx., running time: min. 1.5 hours of continuous operation, charging time: approx. 15 hours; lateral E-Panel for forward and reverse gears. Weight: approx. 12.5 kg.

Pedal version – easy-go pedal-and-rod drive, adjustable seat position. Weight: approx. 8 kg

Pedal version, Silver 80 93 0 444 848
Electric version, 6 V 80 93 2 158 899



BMW M3 GT2. This will bring sportiness to every kid's room: the convertible version of the speedy BMW M3 GT2 motorsport car conveys many features of its larger namesake. We did however cut down on the horsepower. Suitable for ages 3 to 5 approx.

Electric version (6 V): Top speed: 4 km/h approx., running time: minimum 1.5 hours of continuous operation, charging time: approx. 15 hours, weight: approx. 12.5 kg.

Pedal version: Easy-go pedal-and-rod drive, adjustable seat position, weight: approx. 8 kg.

80 93 0 493 878

80 93 0 493 883

Accessories. Make learning traffic safety child's play. International road signs (height 68 cm), traffic cone (height 26 cm) and fully functional traffic lights (height 72 cm) made of durable plastic.

Set 1
80 93 0 396 137

Set 2
80 93 0 396 138



Traffic lights
80 93 0 396 136



Traffic cone
80 93 0 396 139



Set 1



Set 2



BMW MINIATURES.

No matter which BMW brings back sweet memories or makes your heart beat faster, with BMW Miniatures, you can enjoy it today. And it is the combination of lovingly crafted details, stunning design and technical finesse that makes each model so special. Each scale version has its own appeal. Depending on their size, the models don't just feature a detailed reproduction of the engine – characteristic details such as the carpeting of the interior are reproduced faithfully as well, to create a model that really lives up to the original. Are you ready for a test drive?

DISCOVER THE DETAILS.



Love of Detail.

Using advanced software, all the data of a full-scale BMW are converted to scale, with details retained. On 1:87 models, for example, the logo can only be seen under a magnifying glass.



Handmade.

All BMW Miniatures are made by hand, and every single one is subject to post-assembly quality control. The inspectors don't miss the slightest scratch.



Original colours.

The paint finish of BMW Miniatures uses the original BMW paintwork colours. So you can use products from the Original BMW Car Care range to care for your miniatures.



BMW 5 Series Touring. A top performer, even as a miniature. The BMW 5 Series Touring at 1:18 scale does not just allow for the examination of engine and chassis: its Panorama roof also enables you to admire the painstakingly reproduced interior, which features real carpeting. The folding rear seatback, individual seatbelts and visible leather seams on the seats and trim do not just exemplify style, but also great love of detail. This is something that is equally apparent in the exterior, which features original rims complete with BMW logo, a functional fuel tank filler flap and a loving reproduction of the innovative tailgate with dual opening function – as well as that special mix of dynamism and design that you only find in a real BMW.

- Scale: 1:43****
Titanium Silver 80 42 2 158 008
Sophisto Grey 80 42 2 158 009
Imperial Blue 80 42 2 158 010
- Scale: 1:18******
Space Grey 80 43 2 158 014
Black Sapphire 80 43 2 158 015
Deep Sea Blue 80 43 2 158 016



BMW X3. The little brother of the X5 is a big performer, even in miniature. Realistic dimensions and equipment features such as original rims with BMW logo and original paint colours for the interior and exterior make it a real looker. The generous Panorama roof gives you more things to look at, because it reveals an exclusive interior in which every detail is just right. From the faithful reproduction of the chassis to the underbody and exhaust system – the BMW X3 demonstrates why small things can sometimes be really great.

- Scale: 1:43**** (available from 11/2010)
Black Sapphire 80 42 2 162 522
Alpine White 80 42 2 162 523
Vermilion Red 80 42 2 162 524
- Scale: 1:18***
Deep Sea Blue 80 43 2 162 525
Titanium Silver 80 43 2 162 526
Space Grey 80 43 2 162 527
(available from 12/2010) (available from 01/2011) (available from 01/2011)



BMW 5 Series Saloon. Joy at first sight: the generous Panorama window of the 1:18 BMW 5 Series model, along with the opening doors, allows you to admire the detailed reproduction of the saloon's interior. It is a sight worth seeing, with real carpeting, lovingly reproduced seams in the upholstery and a coloured BMW logo on the steering wheel. The exterior impresses with its elegant design and special features. For example, you can open not only the boot lid and bonnet, but also the fuel tank filler flap. The exactly reproduced rims with coloured BMW logo make sure there is more joy in store for you after that first glance.

- Scale: 1:43****
Alpine White 80 42 2 158 005
Black Sapphire 80 42 2 158 006
Space Grey 80 42 2 158 007
- Scale: 1:18******
Titanium Silver 80 43 2 158 011
Sophisto Grey 80 43 2 158 012
Cashmere Silver 80 43 2 158 013



BMW 5 Series Gran Turismo. A classic with a modern twist: this detailed model of the new BMW 5 Series Gran Turismo combines the stylish elegance of a saloon with the flexibility of an estate car and the versatility of a Sports Activity Vehicle. Even as a miniature, the BMW 5 Series Gran Turismo delights the eye with the coupé-like sweep of its roofline – and impeccable workmanship apparent in even the smallest details.

- Scale: 1:43****
Black Sapphire 80 42 2 156 800
Damast Red 80 42 2 156 799

*KYOSHO. **Schuco. ***Herpa. ****Norev.



BMW X1. This car doesn't just look good on a dirt track: at home, this detailed BMW X1 reproduction cuts an equally fine figure. The amazingly realistic rims with the coloured BMW logo give a first indication that small details make a big difference in this case. The 1:18 scale model allows you to open the doors, bonnet and boot lid, for a view that makes every BMW fan's heart beat faster. Even at 1:43 scale, the generous Panorama roof will enable you to admire the faithfully reproduced interior from above. Whichever perspective you choose: precision workmanship ensures that the difference between original and miniature is only apparent from the difference in size.

- Scale: 1:87*****
Black Sapphire 80 41 2 156 808
- Scale: 1:43****
Deep Sea Blue 80 42 2 156 806
Space Grey 80 42 2 156 805
Titanium Silver 80 42 2 156 804
- Scale: 1:18***
Black Sapphire 80 43 2 156 801
Alpine White 80 43 2 156 802
Vermilion Red 80 43 2 156 803



BMW YACHTSPORT COLLECTION.

Driven by the wind, at the intersection of two contrasting elements – yachting holds a unique fascination. In this environment, racing success is critically dependent on choosing the right materials. This is why we guarantee superior functional performance and durability, as well as an unmistakable sense of style. So whether you're on land or battling it out on the high seas, you can always stay in touch with the unique appeal of sailing. With the BMW Yachtsport Collection.

ELEMENTS OF STYLE.

HENRI LLOYD



Henri Lloyd.

We manufacture all fabrics for the BMW Yachtsport Collection in co-operation with Henri Lloyd, whose long-standing experience in producing functional sailing garments has had a decisive influence on the development of this collection.



Match Racer.

In the match race, everything counts. The graphic of the appliqué logo maps the crucial course and the direction of travel.



Decorative maritime flags.

An expression of style in the language of sailors: these decorative emblems are part of the international maritime alphabet and also send out a truly stylish message.



Junior Yachting Longsleeve. White long-sleeved shirt made from comfortable cotton jersey, for fashion-conscious young sailors. With "Match Racer" logo, a sporty sailing design on the front and back, BMW logo and BMW Yachtsport logo.
Material: 100% cotton.

White
Size: 104-152
80 30 2 153 527-531



Men's Yachting Windjacket. Functional, lightweight jacket made from breathable, wind and water-repellent fabric. Concealed hood and handy drawstring at the hem. White/light grey inserts and decorative maritime flags create a stylish look. Waterproof pockets with zip fastener.
Material: 100% nylon.

Blue
S-XXL 80 30 2 153 487-491



Men's Yachting Rugby Shirt. Sporty, long-sleeved rugby shirt. Dark blue with white stripes and white collar.
Material: 100% cotton.

Blue
S-XXL 80 30 2 153 477-481



Yachting Functional Longsleeve. Unisex long-sleeved polo shirt with half zip fastener. Breathable fabric with UV protection. White, grey inserts.
Material: 100% polyester.

White
XS-XXL 80 30 2 153 538-543



Ladies' Yachting Waistcoat. Fashionable fleece waistcoat, white with dark blue inserts, with stand-up collar and two side zip pockets.
Material: 100% polyester.

White
XS-XL 80 30 2 153 522-526

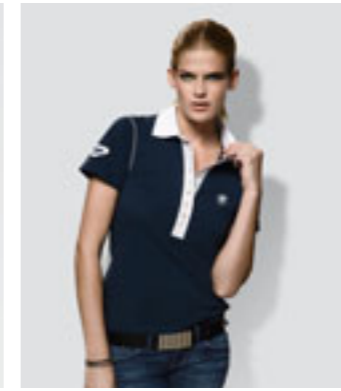

Ladies' Yachting Polo Shirt. Feminine polo shirt with long button placket. The contrasting collar and light grey feature seams make for a sporty look.
Material: 97% cotton, 3% elastane.

Blue
XS-XL 80 30 2 153 502-506



Ladies' Yachting Hoody. Sporty, slightly fitted hooded pullover. All-over stripe design. With V-neck, side slit pockets and drawstrings.
Material: 97% cotton, 3% elastane.

White
XS-XL 80 30 2 153 512-516



Yachting Cap. Functional, dark blue cap in six-panel shape with metal buckle.
Material: 100% cotton.

Blue
80 30 2 153 419

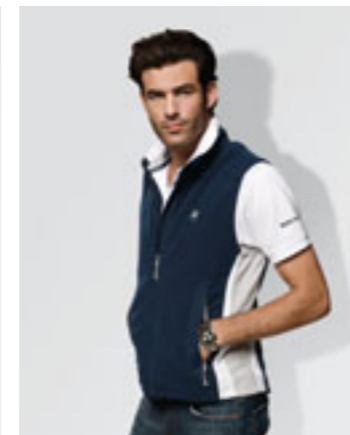

Men's Yachting Waistcoat. Dark blue fleece waistcoat with white inserts, with stand-up collar and two side zip pockets.
Material: 100% polyester.

Blue
S-XXL 80 30 2 153 492-496



Men's Yachting Hoody. White hooded jacket with a trendy striped design in light grey and dark blue. With zip fastener and drawstring collar.
Material: 97% cotton, 3% elastane.

White
S-XXL 80 30 2 153 482-486

Men's Yachting Polo Shirt. Classic men's polo shirt, white with light grey decorative seams.
Material: 97% cotton, 3% elastane.

White
S-XXL 80 30 2 153 467-471



Ladies' Yachting Windjacket. Functional, lightweight ladies' jacket offering protection whatever the weather. White with dark blue/light grey inserts. Concealed hood, waterproof side pockets with zip fastener and drawstring at the hem. Breathable, wind and water-repellent fabric.
Material: 100% nylon.

White
XS-L 80 30 2 153 517-520

BMW COLLECTION
BMW COLLECTION
BMW BIKES & EQUIPMENT
BMW KIDS' COLLECTION
BMW MINIATURES
BMW YACHTSPORT COLLECTION
BMW MOTORSPORT COLLECTION
BMW GOLFSPORT COLLECTION



Yachting Dry Bag. Functional dry bag in an appealing nautical look. 100% waterproof thanks to welded seams. White with decorative flag emblems, printed with "BMW Yachtsport" and "Match Racer".
Material: 100% polyester.

80 30 2 153 426



Yachting Sea Sack. Marine look kit bag. Made from water-repellent material, with impressive storage capacity. A carabiner lock, shoulder strap and carrying handle provide security and comfort. A compass fob is included. White with dark blue stripes, printed with a decorative flag motif, the "BMW Yachtsport" wordmark, and the "Match Racer" logo.
Capacity: 45 l. Material: 100% polyester.

80 30 2 153 421



Yachting Lanyard. Dark blue Yachtsport-style lanyard. Characteristic rope and high-quality metal eyelet. Laser-engraved "BMW Yachtsport" wordmark.
Material: 100% polyester.

Dark Blue
80 30 2 153 424



Yachting Keyring. Dark blue Yachtsport-style key fob. Characteristic rope and high-quality metal eyelet. Laser-engraved "BMW Yachtsport" wordmark.
Material: 100% polyester.

Dark Blue
80 30 2 153 423



Yachting Sunglasses. Sunglasses with blue frame and embossed metal "BMW Yachtsport" wordmark on the arms. Shatter-proof, dark plastic lenses with 100% UVA, UVB, and UVC protection up to 400 nm, corresponding to safety class 3. Sporty protective case and cleaning cloth included.

Blue
80 30 2 153 418

BMW COLLECTION
BMW COLLECTION
BMW BIKES & EQUIPMENT
BMW KIDS' COLLECTION
BMW MINIATURES
BMW YACHTSPORT COLLECTION
BMW MOTORSPORT COLLECTION
BMW GOLFSPORT COLLECTION



BMW MOTORSPORT COLLECTION.

For more than 50 years, BMW has been a key player in the world of motorsport. BMW race drivers like Andy Priaulx have competed for glory in countless race series, many categories, and on all continents. And time and again, they have proven just how successful a combination BMW and motorsport are. The innovative spirit that characterises BMW in touring car championships and motorcycle racing is also a key element of the BMW Motorsport Collection. The ideal outfit for all those who love reaching their goals fast.

LEADING BY INNOVATION.



Gap Board Patch.

The garments are decorated with a fashionably illustrated, carbon-style gap board, just like the one used in motorsport races.



"1" Appliqué.

In building the BMW M3, BMW has designed the most successful touring car of all time. This is why selected garments in this collection come with an appliqué "1".

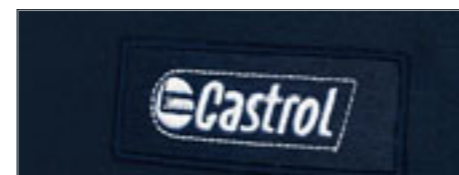

Sponsor Patch.

All garments feature a patch with the Castrol logo, the partner of the BMW Motorsport Team.



Men's Motorsport T-Shirt. Perfect for events and motorsport fans: white sports T-shirt with striking graphic print and BMW wordmark on the back, raglan sleeves with dark blue/red inserts and fashionable patches on the sleeves, chest and bottom right. Neckline and sleeves with dark blue edging.
Material: 95% cotton, 5% elastane.

White
S-XXL 80 30 2 158 171-175

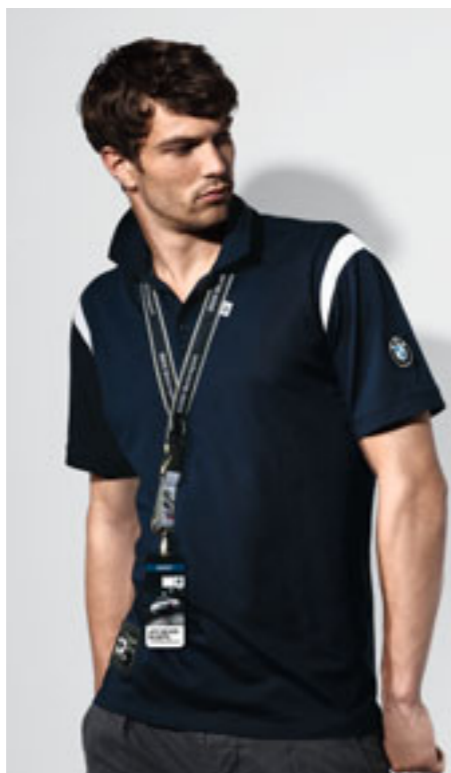

Men's Motorsport Polo Shirt. Classic dark blue polo shirt with contrasting white inserts for a sporty look. Contemporary 5-button placket. Appliqué patches with sponsor logo, "1", and gap board motif. Embroidered BMW Motorsport wordmark on the back and BMW logo on the sleeve.
Material: 100% cotton.

Blue
S-XXL 80 30 0 447 764-768

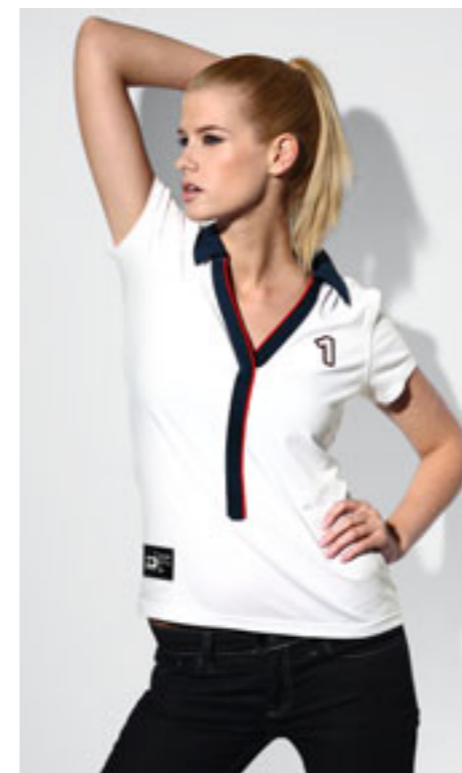

Ladies' Motorsport Polo Shirt. Fitted, fashionable ladies' polo shirt in white, with contrasting blue collar and red piping. Appliqué patches with sponsor logo, "1" and gap board motif. Embroidered BMW Motorsport wordmark on the back and BMW logo on the sleeve.
Material: 95% cotton, 5% elastane.

White
XS-XL 80 30 0 447 779-783



Ladies' Motorsport Top. The look for the fast lane: dark blue, sleeveless ladies' shirt with V-neck. White and red stripe details around the neckline. The BMW Motorsport wordmark and the BMW logo are printed on the back. With "1" appliqué on the front left, sponsor logo on the front bottom right and gap board motif.
Material: 95% cotton, 5% elastane.

Blue
XS-XL 80 30 2 158 186-190



Motorsport Cap. This is the way to keep a cool head – not just at the World Touring Car Championship. Dark blue team cap with five panels, metal closure and embroidered BMW Motorsport logo. The underside of the peak features a decorative printed BMW Motorsport motif.
Material: 100% cotton.

Blue
80 30 2 159 702



Men's Motorsport Longsleeve. Sport and style: dark blue, long-sleeved T-shirt with numerous motor sport accents including a "1" patch on the back, sponsor logo on the right sleeve and gap board motif. The raglan sleeves with white and red inserts at the front and back emphasise the dynamic look of this long-sleeved T-shirt.
Material: 95% cotton, 5% elastane.

Blue
S-XXL 80 30 2 158 176-180



Men's Motorsport Longsleeve. White T-shirt with dark blue long sleeves. Sporty blue contrast piping on the neckline and hem. Front with sophisticated motorsport motif, back with printed BMW Motorsport wordmark. Sponsor logo on the lower sleeve and BMW logo on the side.
Material: 100% cotton.

White
S-XXL 80 30 0 447 759-763



Kids' Motorsport T-Shirt. For a flying start: the neckline and sleeves feature dark blue edging. Unique elements such as the graphic print, the BMW Motorsport wordmark on the back and various patches add dynamic accents. The raglan sleeves with dark blue and red inserts on the sides lend the shirt a sporty, casual look.
Material: 95% cotton, 5% elastane.

White
Size 116/128/140/152/164
80 30 2 158 181-185



Motorsport Rucksack. This sporty rucksack features a trendy mix of materials and provides plenty of space for everything you don't want to go without. A dedicated headphones opening on the special MP3 player compartment and a padded laptop section lend it business capability. The coloured BMW Motorsport print at the front, the handy clip closures on the carry straps, the special BMW Motorsport zip pull and large BMW Motorsport wordmark on the left strap combine sportiness and style in a must-have for every motor racing fan.

White/Blue
80 30 2 179 280



Motorsport Umbrella. There is a good side to rain during a race. At least when you've brought this useful accessory along. Large umbrella in our current motorsport design, with printed BMW Motorsport logo and sponsor logo. Premium fibreglass frame and hard-foam handle with tyre thread design. Handle with inlaid colour BMW logo.
Material: 100% nylon.

Blue
80 30 2 159 700



Motorsport Wallet. This blue wallet is an exciting combination of very different materials. The red piping and large coloured BMW Motorsport logo at the front provide additional highlights. The interior is just as convincing, with a large zippered coin section and various slots for credit cards, documents and notes.

Blue
80 30 2 179 106



Motorsport Lanyard. Sporty lanyard with removable plastic clip and key ring. Strap with woven motorsport motif and BMW Motorsport wordmark.
Material: 100% polyester.

Blue
80 30 2 159 696

Motorsport Sports Bag. The dark blue sports bag with red piping is incredibly spacious: one large main compartment, two side sections, one zippered section each at the front and back as well as three zip compartments in the interior provide generous storage. The large, coloured BMW Motorsport logo at the front and the special BMW Motorsport zip pull give this bag its trademark motor racing looks. The sturdy, easy-care material and adjustable carry handles ensure that you will enjoy this bag for a long time.

Blue
80 30 2 179 105





BMW GOLFSPORT COLLECTION.

Joy has many aspects. One is passion. The passion that makes a day on the green pass in a flash. The passion that motivates us to work for years on that one perfect drive. The passion for a unique sport that is challenging yet relaxing at the same time. The passion found on every golf course. And in every product from the BMW Golfsport Collection.

DRIVEN BY PASSION.



Sporting elegance.

The sporty design of the BMW Golfsport Collection features fashionable green inserts, contrasting stripes, decorative seams and tailored designs.



Equipment without handicap.

From the Umbrella to the Shoe Bag – golfing equipment has to be functional as well as stylish. On the course, everything has to work with perfect precision. Right from the first tee-off.



OGIO Cart Bags.

The Cart Bags by OGIO are true multifunctional marvels, even away from the golf course. This is thanks to eleven special compartments, which include a lined pocket for your valuables and a mobile phone pocket.

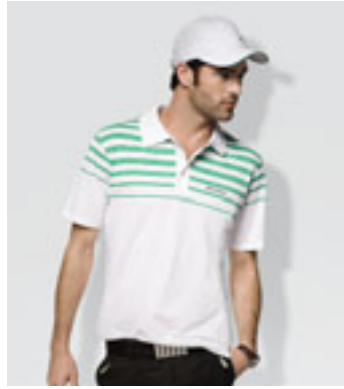

Men's Striped Polo Shirt. Classic white three-button polo shirt. Sporty design with contrasting green stripes. Printed with discreet BMW Golfsport wordmark. BMW logo on the left sleeve.
Material: 100% cotton.

Striped
S-XXL 80 33 2 155 186-190



Men's Functional Polo Shirt. Sporty short-sleeved polo shirt with half zip fastener. Green inserts and decorative seams on the sides and sleeves. Breathable, quick-drying material for optimum moisture wicking. BMW logo on the left sleeve. Printed with the BMW Golfsport wordmark.
Material: 100% polyamide.

White
S-XXL 80 33 2 155 191-195

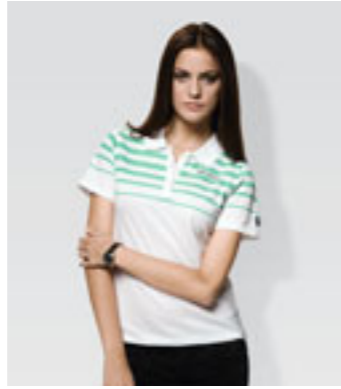

Ladies' Striped Polo Shirt. Sporty polo shirt with three-button placket, white with contrasting green stripes. Tailored fit for a feminine look. BMW logo on the left sleeve. Printed with discreet BMW Golfsport wordmark.
Material: 100% cotton.

Striped
XS-XL 80 33 2 155 196-200

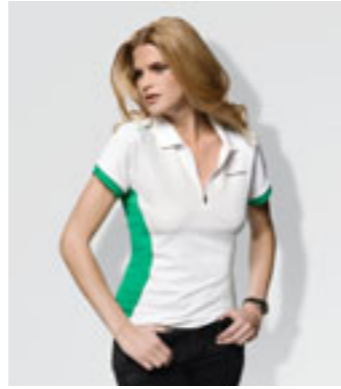

Ladies' Functional Polo Shirt. Feminine polo shirt with green contrasting inserts and decorative seams. Tailored fit for a fashionable look. Breathable, quick-drying material for optimum moisture wicking. BMW logo on the left sleeve. Printed with the BMW Golfsport wordmark.
Material: 100% polyamide.

White
XS-XL 80 33 2 155 201-205



Golf Sports Bag. Roomy sports bag with padded carry strap. Handy front pocket with subdivided interior compartments, ventilated shoe compartment plus accessories pocket on the outside. There is a fleece-lined audio pocket with headphones output at the top. Main compartment with large opening for convenient packing and unpacking. Embroidered with the BMW logo and BMW Golfsport wordmark. BMW Golfsport design in cooperation with OGIO.
Material: leatherette, nylon (white); nylon (black).
Dimensions (L x W x H): approx. 60 x 24 x 29 cm

White
80 33 2 153 377

Black
80 33 2 153 376

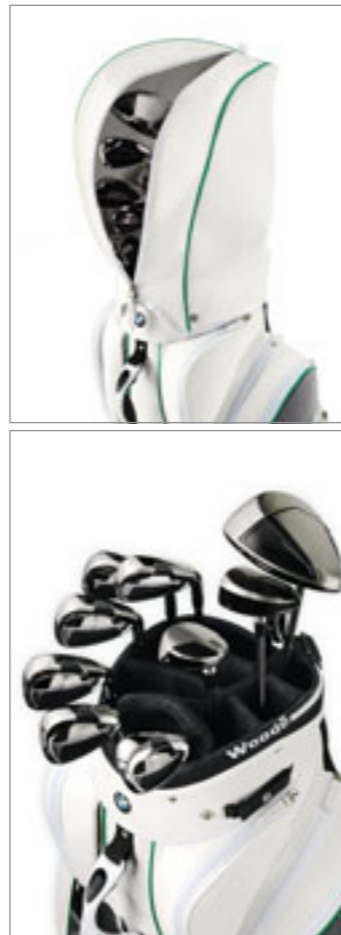

Golf Cart Bag. This highly functional, sporty cart bag is a virtuoso even away from the course. This is assured by eleven special compartments, such as the fleece-lined pocket for valuables, the interior mobile phone pocket and the spacious club compartment with seven subdivisions. Equally practical are the rain hood with zip fastener for easy attachment, the Velcro strip for securing your golf glove, the special tee holder, the insulated drinks compartments, the lift grip for easy handling as well as fasteners for a club cloth and umbrella. With shoulder strap, handy adjustable stand and carry handle. BMW Golfsport design in cooperation with OGIO.
Weight: 4.1 kg. Dimensions (L x W x H): 40 x 35 x 94 cm. Material: leatherette, nylon.

80 33 2 153 378

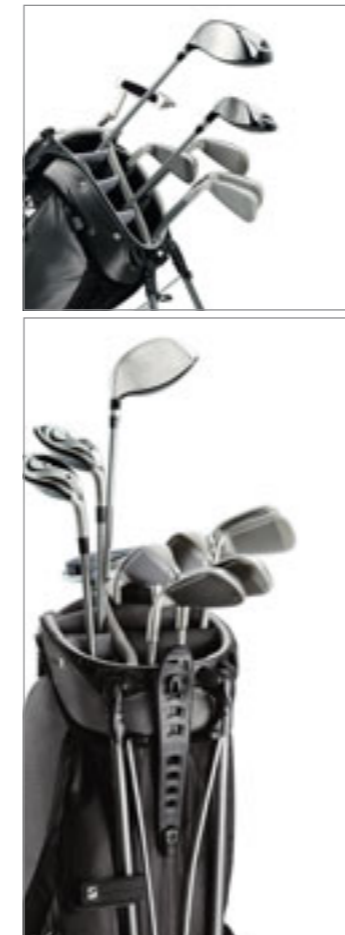

Golf Bag. 9-inch bag with generous interior dimensions and numerous storage compartments as well as a weatherproof, lined pocket for your valuables. Black nylon, with white and silver accents and embroidered logos. Padded, rubberised opening to protect your golf clubs. Optimum comfort thanks to double backpack carrying straps. With drinks compartment (0.5 litres) and anti-twist cart strap to secure bag to trolley or golf buggy. Zipless ball pocket for optimum access to spare balls and tees. BMW Golfsport design in cooperation with OGIO.
Dimensions (L x W x H): approx. 23 x 38 x 93 cm

80 33 0 421 826

BMW COLLECTION
BMW COLLECTION
BMW BIKES & EQUIPMENT
BMW KIDS' COLLECTION
BMW MINIATURES
BMW YACHTSPORT COLLECTION
BMW MOTORSPORT COLLECTION
BMW GOLFSPORT COLLECTION



Golf Travel Cover. For two golf bags or one stand bag. Black nylon, with white and silver accents. PVC floor, inner strap for securing bags, accessories pockets. Integrated wheels, padded shoulder strap. BMW Golfsport design in cooperation with OGIO.
Dimensions (L x W x H): approx. 130 x 49 x 48 cm

80 33 0 421 827



Golf Umbrella. Elegant black umbrella. Silver and white contrasting stripes. Polyester with water-repellent Teflon coating and UV-reflective finish. Original birdiepal Windflex frame with fibreglass struts. Printed with the BMW Golfsport wordmark.
Diameter: approx. 120 cm, height: 98 cm

Black
80 33 2 153 379



Golf Cap. Elegant cap with curved sandwich peak. Adjustable closure. Black: embroidered stripes on visor. White: understated, green piping. With BMW pin, embroidered with the BMW Golfsport wordmark.
Material: 100% cotton.

White
80 33 2 153 375



Black
80 33 2 153 374



Golf Shoe Carrier. Functional shoe bag made from dirt-repellent material. Ventilated pocket with zip fastener on the front, e.g. for accessories or soft spikes. The large, wipe-clean main compartment offers plenty of room for golf shoes up to a size 49. Another handy feature is the fold-down partition to fasten shoes securely in place. Neoprene-reinforced grip for carrying comfort. Embroidered with the BMW logo and BMW Golfsport wordmark. BMW Golfsport design in cooperation with OGIO.
Material: leatherette, nylon (white); nylon (black).
Dimensions (L x W x H): approx. 30 x 9 x 36 cm

Black
80 33 2 153 381

White
80 33 2 153 382



Golf Umbrella. Fashionable umbrella, white with contrasting green stripes. Address panel on the inside of the fastening strap. Printed with the BMW Golfsport wordmark. Diameter: approx. 120 cm, height: 98 cm

White
80 33 2 153 380



Green Set. Black nylon with the BMW Golfsport wordmark. With pitch fork, tee compartment with three tees, pencil, carabiner and scorecard compartment. The pitch fork has an integrated ball marker with a BMW logo.
Dimensions (L x W x H): approx. 6.5 x 2 x 11 cm

Black
80 33 0 422 936



Golf Gift Set. The right kit for a successful day on the course. The set includes three Titleist ProV1 golf balls, a pitch fork, a ball marker, a club towel and ten golf tees. Delivered in quality presentation box.

80 33 2 159 428



Titleist ProV1 Golf Ball. Low compression, thin, soft urethane/elastomer cover, for precise long shots. Core diameter: 1.53" (3.89 cm)

80 33 0 427 408



Standard Pinnacle Gold Distance Golf Ball. Low core compression (around 70), soft surlyn cover for spin and control with irons and wedges. Set of three balls.

80 33 0 393 066



Club Cloth. 3-layer, black, 100% cotton. Stripes in white and grey, with burnt-out "BMW Golfsport" lettering. Metal hook for attachment to golf bag.
Dimensions (L x W): 38 x 52 cm

80 33 2 153 383



Golf Tees. Five golf tees, white, 100% birch wood, grey BMW Golfsport print on the shaft.

80 33 0 393 064



Drinks Bottle. Made from extremely lightweight aluminium, with plastic screw top, aluminium carabiner and "BMW Golfsport" wordmark on the bottle. Black neoprene cover with BMW logo stud for insulation.
Capacity: 0.75 litres

Black
80 33 0 422 938



JOY COMES IN MANY FORMS. BMW WELT.

Discover BMW Lifestyle in the shop at BMW Welt, the delivery centre in Munich. The shop offers a unique selection of high-quality and elegant products on two floors. The range includes stylish travel bags, innovative bikes to suit all requirements, sporty clothing, exclusive leather goods as well as golfing, yachting and motorsport accessories.

Experience joy. Discover the comprehensive product range available in the BMW Lifestyle Shop at BMW Welt.

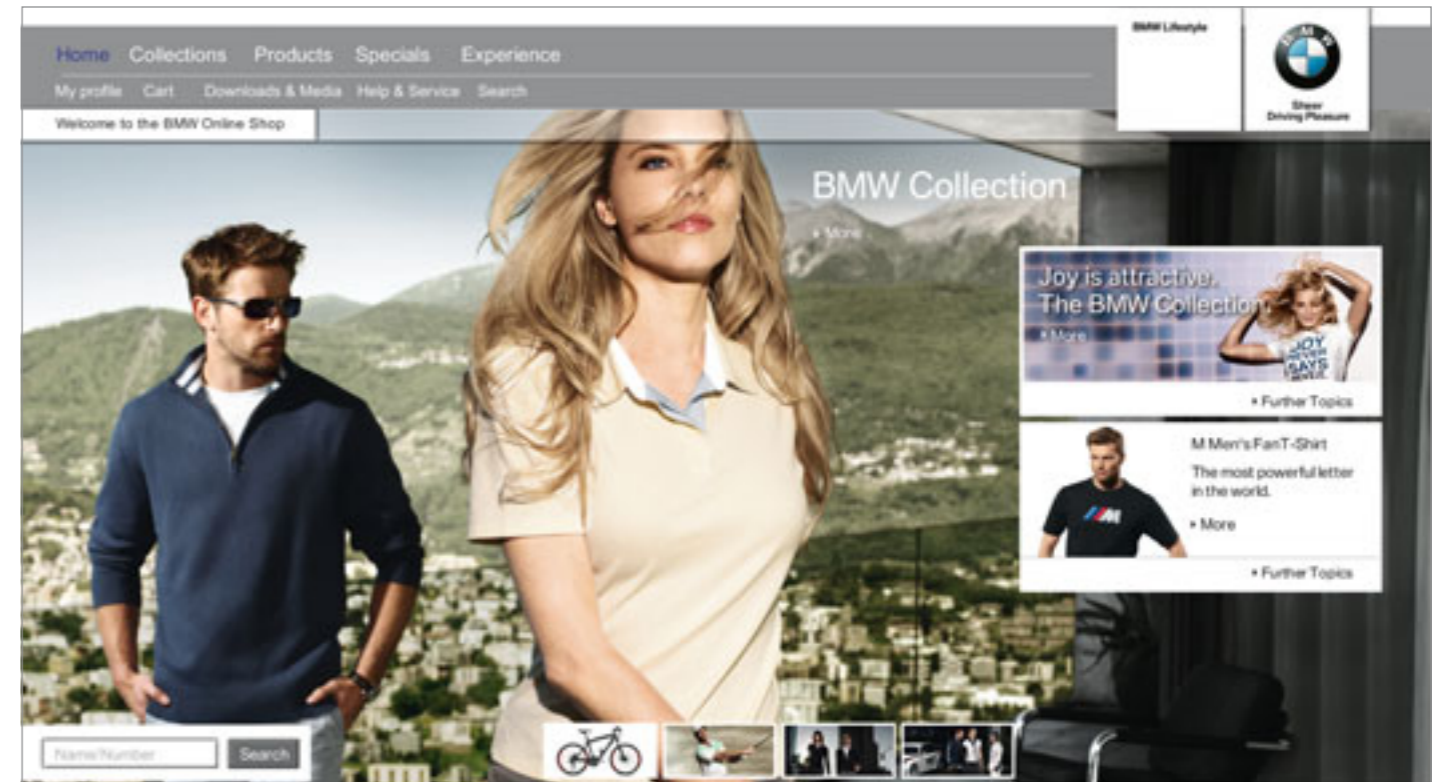

ENTER THE EXCITING WORLD OF BMW LIFESTYLE.

Our fascinating BMW Lifestyle products are just a click away, at www.bmw-shop.com. Here you can find detailed information on all BMW Lifestyle products. And experience sheer riding pleasure in the interactive experience area for the BMW Bikes & Equipment. Use the Online Configurator to design your dream bike. Or get yourself some great downloads such as high-resolution wallpapers and the BMW Bikes video.

GET MORE BMW LIFESTYLE AT YOUR BMW DEALER. AND AT WWW.BMW-SHOP.COM



JOY COMES IN MANY FORMS. BMW WELT.

Discover BMW Lifestyle in the shop at BMW Welt, the delivery centre in Munich. The shop offers a unique selection of high-quality and elegant products on two floors. The range includes stylish travel bags, innovative bikes to suit all requirements, sporty clothing, exclusive leather goods as well as golfing, yachting and motorsport accessories.

Experience joy. Discover the comprehensive product range available in the BMW Lifestyle Shop at BMW Welt.

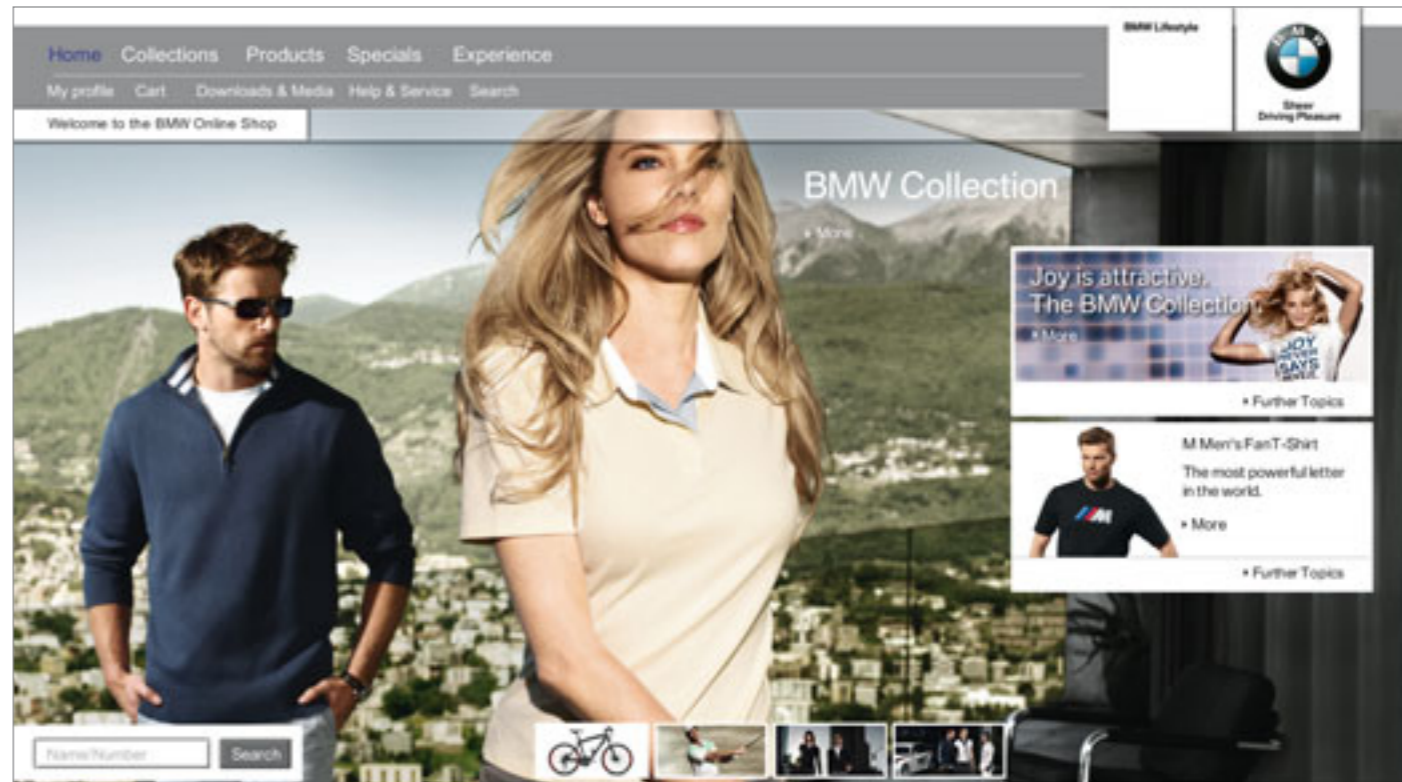

ENTER THE EXCITING WORLD OF BMW LIFESTYLE.

Our fascinating BMW Lifestyle products are just a click away, at www.bmw-shop.com. Here you can find detailed information on all BMW Lifestyle products. And experience sheer riding pleasure in the interactive experience area for the BMW Bikes & Equipment. Use the Online Configurator to design your dream bike. Or get yourself some great downloads such as high-resolution wallpapers and the BMW Bikes video.

GET MORE BMW LIFESTYLE AT YOUR BMW DEALER. AND AT WWW.BMW-SHOP.COM

BMW Lifestyle



Sheer
Driving Pleasure

www.bmw-shop.com



Subject to misprints, errors and change without notice. Supplies while stocks last.
© BMW AG, Munich, Germany. Not to be reproduced wholly or in part without written
permission of BMW AG, Munich. This brochure was printed in an environmentally-
friendly process on chlorine- and acid-free paper.